



CANADA
4-H Saskatchewan

Welding

Reference
Guide

4-H Motto

'Learn To Do By Doing'

4-H Pledge

'I pledge

My Head to clearer thinking,

My Heart to greater loyalty,

My Hands to larger service,

My Health to better living,

For my Club, my community and my country'

4-H Grace

(Tune of Auld Lang Syne)

We thank thee, Lord, for blessings great

On this, our own fair land.

Teach us to serve thee joyfully,

With head, heart, health and hand

Funding for this project has been provided by Agriculture and Agri-Food Canada through the Canadian Agricultural Adaptation Program (CAAP). In Saskatchewan, this program is delivered by the Agriculture Council of Saskatchewan. No portion of this manual may be reproduced without written permission from the Saskatchewan 4-H Council, phone 306-933-7727, email: info@4-h.sk.ca. Developed December 2013.

This material was written by *Christine Korol*



CANADA
4-H Saskatchewan



Agriculture and
Agri-Food Canada

Agriculture et
Agroalimentaire Canada



AGRICULTURE COUNCIL
OF SASKATCHEWAN INC.

TABLE OF CONTENTS

UNIT 1 WELDING 101	1
CHAPTER 1: WELCOME TO WELDING	2
CHAPTER 2: THE W'S OF WELDING: WHAT? WHY? WHO?	3
CHAPTER 3: DRESSING THE PART	6
CHAPTER 4: WELDING SAFETY	14
CHAPTER 5: TOOLS OF THE TRADE	19
UNIT 1 RESOURCES	20
UNIT 2 ALL ABOUT ARC	22
CHAPTER 1: TALK THE TALK	23
CHAPTER 2: A VERY BRIEF HISTORY	26
CHAPTER 3: HOW IT WORKS	27
CHAPTER 4: LET THE SPARKS FLY	32
CHAPTER 5: CLEANING UP	35
UNIT 2 RESOURCES	36
UNIT 3 READY, SET, WELD	37
CHAPTER 1: RUNNING A STRINGER BEAD	38
CHAPTER 2: ARC LENGTH	40
CHAPTER 3: ELECTRODE ANGLE	42
CHAPTER 4: CURRENT SETTING (AMPERAGE)	44
CHAPTER 5: TRAVEL SPEED	46
CHAPTER 6: RE-STARTING, STOPPING AND FINISHING	48
CHAPTER 7: TRYING IT ALL TOGETHER	50
UNIT 3 RESOURCES	53
UNIT 4 EXAMINING ELECTRODES	54
CHAPTER 1: CHOOSING THE CORRECT ELECTRODE FOR THE JOB	55
CHAPTER 2: POLARITY	57
CHAPTER 3: CLASSIFICATION	60
CHAPTER 4: STORING ELECTRODES	64
CHAPTER 5: PREPPING FOR WELDING JOINTS	65
UNIT 4 RESOURCES	66
UNIT 5 WORKING WITH WELDS	67
CHAPTER 1: JOINTS	68
CHAPTER 2: WELDING DIFFERENT JOINTS	71
CHAPTER 3: MAKING WIDER AND BIGGER WELDS	76
CHAPTER 4: DISTORTION	79
UNIT 5 RESOURCES	82

UNIT 6 MASTER NEW SKILLS	83
INSTRUCTIONAL DICTIONARY INDEX.....	84
UNIT 6 RESOURCES.....	102
UNIT 7 PERFECTING YOUR TECHNIQUE	103
CHAPTER 1: MAKING GOOD WELDS	104
CHAPTER 2: TROUBLESHOOTING	106
CHAPTER 3: TIPS N’ TRICKS	115
UNIT 7 RESOURCES	117
UNIT 8 WRAPPING UP	118
CHAPTER 1: GETTING READY FOR ACHIEVEMENT DAY	119
CHAPTER 2: JUDGING.....	120
CHAPTER 3: THAT’S A WRAP	122
UNIT 8 RESOURCES	123
APPENDIX	124
THE WELL-DRESSED WELDER	125
TABLES	126
ACTIVITY WORKSHEETS.....	127
PROJECT PICKER	137
WELDING TERMS.....	140
RESOURCES	150
ACKNOWLEDGMENTS	153

Unit 1

Welding 101



©BNP Design Studio * [illustrationsOf.com/210240](https://www.illustrationsOf.com/210240)

Bring with you to the meeting:

- Pen or pencil
- Notepad

In this Unit we will:

- Talk about how important welding is to our lives.
- Learn what type of clothing and gear we need for welding.
- Discuss the dangers of welding and how to protect ourselves from them.
- Look at some common welding tools.
- Make a list of “Shop Rules” for our club to follow.

CHAPTER 1: Welcome to Welding

This project is an introduction to **welding** where we will be learning how to arc weld. If you have no experience welding, this project is the perfect place to start. If you already do have some experience welding you've also come to the right place because you will have the opportunity to hone your skills, learn new things and by the end of the project, you will definitely be better at welding than you are today.

Since you're here and enrolled in this 4-H project you probably have a good idea of what welding is and a reason for wanting to learn how to weld. Maybe you want to be able to fix broken farm machinery. Maybe you like working with your hands and want to try something new. Or maybe you're creative and can't wait to turn that great ideas in your head into reality. You could even be an artist hoping to make sculptures out of metal or a high school student wondering if you should consider a career in welding. Perhaps you have an entirely unique reason for being here or are just curious about welding and want to see what it's all about. Whatever your reason, this project will help you work towards your goals by giving you lots of hands on experience and practical knowledge.

Before we dive into the world of welding, let's take a moment to get to know each other and find out why we're all here.

Spark of Information

Do you want to learn how to stick weld, electric arc weld or use SMAW? You're in luck! These are all just other names used for arc welding.



ACTIVITY

#1. Meet, Greet and Goals

CHAPTER 2: The W's of Welding: What? Why? Who?

What is Welding?

Welding is the process of joining pieces of metal together. It is the most common, economical and efficient way to join metals permanently. There are other ways to connect two pieces of metal together (like riveting) but welding is the only way to join pieces of metal together so that they act as a single piece. This is done by melting part of each piece and adding a filler metal to form a **joint**.

There are many different ways to weld including using a gas flame, an electric arc, a laser and even an ultrasound. As technology continues to advance, new ways to weld are being developed. Welding can also be done anywhere: inside, outside... even underwater and in outer space!

weld, the result is a high strength joint (if done correctly, of course). Because of this, as well as the number of different welding methods that have already been developed, welding can be used to build massive structures like bridges and skyscrapers, small objects like pens and door knobs and intricate ones like cars and airplanes.

Have you ever really stopped to think about all of things that we use in our day to day lives that have been welded together? The list is endless.

Hot Tip

Many welders learn how to arc weld first before moving on to other types of welding like MIG and TIG.



ACTIVITY

#2. Here a Weld, There a Weld, Everywhere a Weld

Why Weld?

Once we've stopped to think about how many of the objects we depend on are made of metal we can start to see why welding is so important and why we need it.

Could you image if suddenly, all at once, all of the welds in the world came apart? It would be catastrophic! Just picture it. Skyscrapers would crumble down on themselves. Vehicles would flop into heaps of parts in the middle of the road. Ships would fall apart and sink. Airplanes would drop out of the sky in pieces. Farmers wouldn't have any of the tools and machinery they need to produce a crop. Even the way you pass your day and what you do inside of your house would be

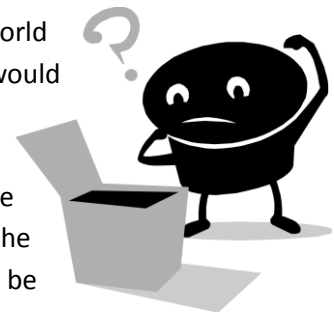

affected. What would you eat without having a fridge, stove, microwave or toaster? Where would you sleep since most likely your bed has collapsed? How would you spend your free time without a computer, TV, radio or telephone?

It's easy to see how different and much more difficult life would be without all of these metal things that are held together by welds. But, the scope of how much welding affects our daily lives goes beyond this. Many of the objects around us that are not made of metal are made from a machine that is made of metal and welds. This includes things like clothing, dishes, furniture, building materials and books.

Without metals and the ability to weld them we would have to resort to using materials like stone and wood for all of our needs. These materials would work to replace some of the products we know as common necessity, but many, like computers, would be impossible to replace and most of our ways to manufacture products would disappear.

Would you believe that welding serves another purpose beyond all of this? It does. Welding is also used to make things better and stronger. For example, a bridge made of one single plank is not nearly as strong as a bridge made of several pieces welded together, like a box girder bridge. Even if we join these pieces together with a method other than welding, they wouldn't be nearly as strong as if they were held together by welds.

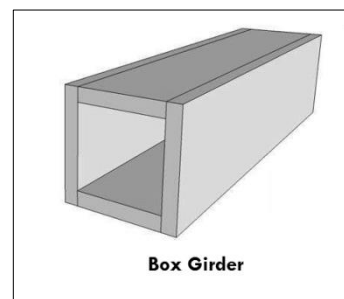
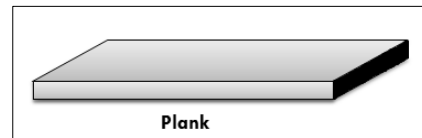

ACTIVITY

#3. Chocolate Welding

Who Welds?

Welding is a great skill to learn so that we can build our own projects and do our own repairs. Plus, it's a skill that almost anyone can develop.

In order to work as a **welder**, you need to have good eyesight and be healthy and fit enough to be able to bend, stoop and work in awkward positions. And, most importantly, you need to have patience and be willing to practice and receive training because as you will see in Unit 2, it takes just a few minutes to learn how to run a **weld bead**, but a lot of practice and patience before you can weld something to be structurally sound.

Thankfully, the other skills required to be a good welder can be developed with all of the practice you'll be doing. This includes things like good hand-eye coordination, the ability to concentrate on detailed work for long periods of time and having **manual dexterity**.

Since we already know that almost everything we use in our daily lives are welded or made by equipment that is welded we could probably imagine all of the job opportunities available to a welder.

Welders work in construction, shaping the world around us with bridges and buildings. They work in manufacturing, building machines for agriculture, mining, construction and our everyday transportation. They work in mining and oil and gas extraction and in smelting and refining plants. They work in the electric and electronics industries making our household appliances. And of course they work in repair and maintenance.

In any of these fields, welders can advance to work as supervisors, inspectors, or even instructors. They can work locally, for a large company, overseas, out in the ocean on oil rigs or be self-employed.

And, if you're thinking about farming, welding would be an invaluable skill for you to have. Knowing how to weld not only saves farmers money by not having to hire a professional but also saves time... which is always precious when you're counting on crops and the weather.



ACTIVITY

#4. Finding Metal for Projects

CHAPTER 3: Dressing the Part

When welding, there are a number of potential dangers for you and for others around you. These dangers include things like electric shock, burns, eye damage, toxic fumes and fire. That's a pretty intense list, but the good news is that welding can be a safe activity when measures are taken to protect ourselves from these potential hazards.

The first thing you can do to protect yourself when welding is to dress appropriately. Just like firefighters wear clothing to protect from burns and construction workers wear hardhats to prevent injury, welders dress head to toe in gear that will help them prevent injury and protect themselves.

Instead of just looking at a list of all the gear we need to wear when welding, let's find out exactly what we're protecting ourselves from in the first place and how we can dress from the top down to keep ourselves safe.

Protecting Your Face and Eyes

In arc welding an extremely bright light is created, which gives off **ultraviolet (UV) and infrared radiation**. Even just briefly exposing your eyes to this radiation can cause eye burn known as **welder's flash**. This is a condition, whose symptoms can take effect hours after exposure, that causes extreme discomfort and can even result in swelling, fluid excretion and temporary blindness. Yikes! Usually welder's flash is temporary, but repeated or prolonged exposure to the bright light created when we arc weld can lead to permanent eye damage, like cataracts or retinal burning.

To protect your eyes from this radiation you could just simply never look at an **arc**, which is the source of the bright light. That would be fine if we were just passing by a room where someone was welding. But, of course, keeping your eyes closed when you're the one doing the welding isn't an option, as doing so would create more hazards... and result in some pretty poor quality welds.

So that's where welding helmets come in. Welding helmets have a filter shade in the visor, which protects eyes by blocking out the harmful radiation. Helmets also protect the face from hot metal spatter, sparks and other flying debris.

The filter shades in welding helmets come in a range of shades – from a No.8 (lightest) to a No. 14 (darkest). It may seem to make the most sense to always use the darkest shade available so you get the best protection for your eyes. But, unfortunately, this strategy won't work. Some welding operations create less light

Hot Tip

Check out Table No. 1 in the Appendix – it will help you to choose the right filter shade for the welding job you're working on.

than others and a dark filter shade would block out too much light, making it impossible to see what you're doing. This means you need to match the filter shade in your helmet with the welding operation you're performing.

As a rule of thumb, when you're trying to choose the shade that is right for you and what you're welding, start with a shade that is too dark (you'll know that it is too dark because you will have trouble seeing the "weld zone" – the place where you are welding). Then, switch to lighter shades until you get to one that allows you to sufficiently see the weld zone. If you see white spots in your vision after you've stopped welding, the filter you are using is not dark enough.

There are two different types of welding helmets. **Fixed shade helmets** and **auto-darkening helmets**, each with pros and cons.



With fixed shade helmets, it is very difficult to see much of anything through your visor until you strike an arc. This is why the signature welding head nod, which flips down a helmet exists. With their helmet up, welders set up their hand position to start a weld so they can see what they're doing and then at the last moment before striking an arc they lower their helmet with a quick nod. These helmets also require you to manually change the filter to a different shade when you change welding operations.

Auto-darkening helmets add convenience to a welder because you never have to manually change a filter. There is a dial right on the helmet that you can turn to adjust the darkness of the filter, without even taking the helmet off. This is a great feature if you are changing welding tasks throughout your day or if you're unsure about which filter you'll need for the welding task at hand. But the best feature of these helmets is, of course, that they auto-darken. This means that while the helmet is down you can see clearly through the lens and that as soon as you strike an arc the lens darkens to the filter shade selected. This darkening happens fast – in 4/10 of a millisecond, which is fast enough to protect your eye from any damage.

It's because of these features that auto-darkening helmets are becoming an industry standard. Despite this, fixed shade helmets are not going to go extinct any time soon because there are certain welders, like pipeliners, who will always prefer to use them. For the welding that we will be doing in this project, either type of helmet will do just fine. However, if you do need to buy a new helmet, you will most likely prefer the features of an auto-darkening helmet. Fortunately, some auto-darkening helmets with the standard features discussed here are comparable in price to fixed-shade helmets (while ones with more features can be quite expensive). When choosing a helmet, the most important things are that it fits properly so that you can see where you're welding and that it is comfortable.

Helmet Handling

Normally helmets have a clear lens on either side of the filter to protect the filter lens from being damaged. But if you do scratch, crack or chip the filter it needs to be replaced. Scratches on the filter allow dangerous UV and infrared light to pass through and so even though you're wearing the helmet, you won't be properly protected. (Even if you don't think your eyes are bothered by the light that is passing through the crack or chip, you would still be damaging them.)

When welding, it is important to always clearly see what you're doing. So, make sure that you clean your lens often, because it is guaranteed that it will get dirty quickly once sparks and spatter start flying. If the clear lens on your helmet gets scratched, you'll want to replace it too, since the scratch will get in your way of seeing clearly. However, replacing a scratched clear lens isn't urgent like replacing a scratched filter lens, because a scratched clear lens won't injure your eyes, it will just be a nuisance.

And remember, it is absolutely necessary to protect your eyes from the radiation given off during arc welding; welder's flash can occur from just a few seconds of looking directly at a welding arc. Never look directly at an arc without proper eye protection.

ACTIVITY



#5. Parts of a Helmet



#6. Types of Helmets

Protecting Your Eyes

Beyond using a welding helmet, we need to protect our eyes, especially in arc welding, from flying debris. To properly protect our eyes we need to wear safety glasses or goggles at all times

while welding. And yes, this does mean wearing your welding helmet and safety glasses at the same time so choose ones that are comfortable for you to wear underneath your helmet.



The reason you need to wear your helmet *and* other eye protection at the same time is because **slag** chips, grinding fragments and other debris can ricochet under your helmet. If you choose safety glasses over goggles you should look for ones with side shields because they offer better protection, not only from debris but also from indirect UV rays.

Prescription eye glasses are *not* a substitute for proper eye protection. If you cannot find safety glasses or goggles that fit comfortably over your glasses, there are safety glasses and goggles that can be fitted with prescription safety lenses. If you wear contact lenses it is safe to wear them while welding. But, of course, they offer no protection against the hazards of welding, so you still need your safety glasses or goggles.

Protecting Your Head

Even with a helmet and safety glasses on there is still one part of your head that is not protected from sparks and burns; your scalp and your hair. Welders protect this part of their body with caps known as **skull caps**, or welder's beanies. These caps are made from fabric that is flame-resistant.



Protecting Your Ears

Could you imagine how much it would hurt, and how damaging it would be, to have sparks or hot metal fly into your ear canal? That thought alone should be enough to make you want to wear ear protection. You should be especially conscious of wearing ear protection if you are welding overhead since this is when the danger of hot metal falling on your head is greatest.

You also need to protect your ears from excessive noise while welding. Repeated exposure to loud noise can cause permanent damage to your hearing. This type of hearing loss is gradual and can really compound over time. It is hard for us to tell how loud a noise has to be to cause damage to our ears, because, often, we don't feel any pain or have any indication that the noise is harmful. The only symptom is hearing loss, which you may not even realize you



have until you take a hearing test. By the time hearing loss happens, it is way too late.

In arc welding, the noises we are exposed to, especially when using a chipping hammer, are great enough to cause damage to your ears. To protect our ears from both noise and hot debris you can use ear muffs or ear plugs. Either will provide adequate protection against hearing loss, but ear muffs will better protect your entire ear. You should choose the type of ear protection that you find the most comfortable.

Protecting Your Body

Wearing the correct clothing while welding not only protects welders from burns caused by sparks and weld spatter but, also from **arc radiation**. Like the sun, the UV radiation given off during welding causes skin burns. That means that if all of your skin isn't covered, you may be surprised to go home after a day of welding with a severe "sunburn".

To protect ourselves properly, we need to:

- Wear clothing that covers all of our body. You can either choose to wear coveralls or a long sleeve shirt (no v-necks).
- Wear clothing that is free of any frays or tears.
- Wear clothing that fits properly, allowing you the ability to move freely but not be baggy and loose.
- Eliminate places in your clothing where hot metal can get trapped. This means unrolling any cuffs on your pants and sleeves, tucking your shirt into your gloves and wearing your pants over top of your boots.
- Wear clothing that is free of grease and oil, since these substances ignite easily.
- Make sure you never carry anything flammable in any of your pockets like cigarette lighters or matches and avoid carrying paper in your breast pocket.

Spark of Information

Labels inside of clothing will specify what materials they are made from. For example, a tag in a shirt may say "65% cotton, 35% polyester," making it unsuitable for welding because it is not made of 100% natural materials.

Believe it or not, the material that our welding clothing is made of plays a very important role in protecting us. When welding, we need to avoid clothing that is made of **synthetic materials** because they melt easily. These include things like polyester and nylon. Instead, we should choose clothing that is made of



natural material like leather, wool, denim or heavy cotton.

Of these natural materials, leather is the most expensive and provide the best protection and durability. You'll find professional welders wearing leather aprons, jackets and chaps. Tightly knit wools give the second best protection, but may be hard to find. Denim is a common, and good, material to wear while welding and so is heavy cotton. Both these options are less expensive and easier to find. Lightweight clothes, even if made of natural material, should be avoided because heavy spatter will burn through them quickly. If you are shopping for new clothes to wear while welding, buying ones that are special treated to be flame retardant are the most ideal.



Protecting Your Hands

Your hands are the closest thing to the hot material when you're welding and are constantly splashed with metal and flying sparks. The only thing that will protect your hands against all of this is leather **gauntlet gloves**, which are long leather gloves that will cover your wrists and much of your lower arm.

It is important that your gloves don't have any holes so sparks can't get inside of them. Hole-free gloves will also insulate you better which helps protect against electric shocks. You should also make sure to keep your gloves dry for this same reason.



Grabbing hot metal while wearing gloves can still hurt your hand and can cause gloves to shrink, and become stiff and hard. So even while wearing gloves using pliers to grab hot metal.

Protecting Your Feet

Guaranteed if hot metal gets inside of your shoe you'll drop everything to get it out. The result might not only be a bad burn, but in your panic you may drop something you're working with that could cause more serious problems like a fire.



To avoid a problem like this, never wear low cut shoes when welding. This includes slip on shoes and loafers. Nylon running shoes are also a bad idea because if exposed to high heat, they could melt to your foot.



The best thing to wear on your feet when welding is some sort of work boot. Ones made with leather and that have steel toes are best.

Make sure to keep boots laced to avoid tripping and to keep your pants over your boots so that hot metal and sparks cannot fall into the rim of your boot and cause burns.

The Well-Dressed Welder

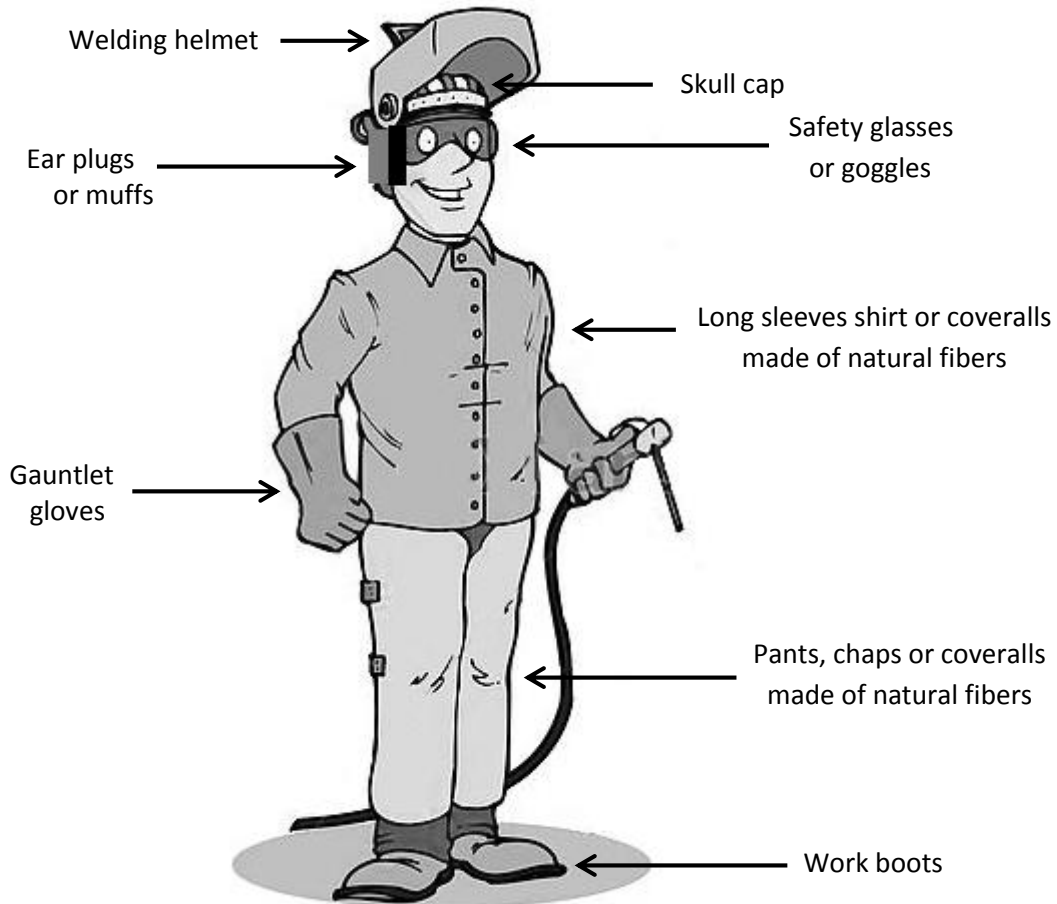

Hot Tip

Wondering where you can buy all of this safety gear? Welding supplies stores and stores like Peavey Mart, Princess Auto and Canadian Tire should sell everything that you need. But, check tags on existing clothing first because you might already own some clothing that is appropriate to wear while welding.

ACTIVITY



#7. The Good and the Bad



#8. The Right Gear



#9. Gear Guide



#10. At the Store

CHAPTER 4: Welding Safety

Even when dressed properly, we still have to take extra safety measures to protect ourselves from other things that can cause injuries or even death – things like electric shock, fumes, gases, fire and explosions. Below is a list of things you can do to insure safety for yourself and for others while welding:

1. **Inspect equipment before beginning to weld.** Every day before starting to weld we need to inspect our welding equipment to make sure that everything is in good working order and connected properly. We will learn about the arc welding machine and what to look for in our inspection in the next Unit. If you find something in this safety check that you think could pose a hazard tell your leader or disconnect the power source and ask a qualified repair man.
2. **Keep your work area clear of clutter and tripping hazards.** This is important because if you, or someone passing by your welding station trips, you could be injured by shock, hot metal or falling. To avoid accumulation of dangerous clutter clean up at the end of every day and periodically throughout the day by rolling up cables, organizing your tools and sweeping the floor.
3. **Never weld on containers that hold or have held flammable materials.** Doing so is extremely dangerous and could result in an explosion.
4. **Be aware of fire hazards around you.** The heat of a welding arc can get as hot as 5,500°C and sparks and molten metal from your work can spray more than 10 metres! So make sure you distance yourself at least 10 metres from any combustible materials, which includes things like rags, wood, paper, gasoline and oil.
5. **Know where the fire alarms, fire extinguishers and exits are located.** If you do have an emergency the first thing to remember is don't panic, shut off your welder if possible and get out. Alert the fire department by pulling an alarm or calling 9-1-1. If the fire is small enough to safely put out allow your leader to do it.
6. **Use fire-resistant screens and curtains when working around others.** If working in close proximity to others, using fire-resistant screens or curtains will protect them from being hit by sparks and spatter and protect their eyes from the light given off when welding.
7. **Keep your head out of the *fume plume*.** The fume plume is the visible column of fume that rises from the spot where you're

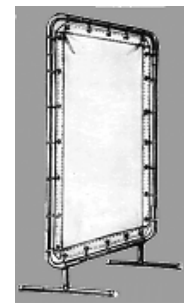

welding. It contains solid particles from the **electrode, base metal** and base metal coating. Exposure to these fumes can cause burning eyes and skin, dizziness, nausea and fever.

8. **Be aware of hot metal and know how to handle it.** Metals can get up to 1,000°C and have no change in colour to indicate that they're hot. As a safety precaution, with your gloves on, tap metal to see if it really is cool enough to touch before grabbing it. If metal is hot, it should always be handled with metal tongs or pliers. If you leaving hot metal somewhere to cool, write "HOT" on it with **soapstone**. If you do receive a burn, make sure you tell your leader.



9. **Have proper ventilation.** Proper ventilation can help direct the fume plume away from your face. It is also needed because some gases produced during arc welding can be toxic and others displace oxygen, making a shortage of oxygen in the air you breathe, which could lead to dizziness or even unconsciousness. If you feel dizzy or nauseous try to improve ventilation in your area. If that doesn't work, turn off your welder, get some fresh air immediately and notify your leader.

Depending on where you're welding natural ventilation may be adequate. This includes the wind if you're working outside or the flow of air through open windows and doors if you're working inside.

When you need more ventilation than this, because of where you are welding, what you are welding, and how many welders are being operated in the same area, other ventilation can come from fans to help move air through the workplace or exhaust hoods that captures fumes at or near the arc.

10. **Avoid possible shock hazard.** Shock is one of the most serious risks to a welder. Contact with metal parts that are **electrically hot** can cause injury or death because of the shock. When a welder is in use, and when it is idling, the electrode and all parts in the **welding circuit** are electrically hot.

There are two types of electrical shocks an unsafe welder can receive: **primary voltage shock** or **secondary voltage shock**.

Primary voltage shock is very dangerous because of how strong it is (230-460V). While the welder is plugged in, even if the welder is off, you can receive this type of shock by touching the inside of a welder and any other **grounded** metal at the same time, including the welder frame and casing. To avoid a primary voltage shock you should:

- a. Never remove a fixed panel from your welder.
- b. Never weld with any of the welder's covers removed.

- c. Make sure that your welder is always properly grounded.
- d. Never ignore a blown fuse, which is a warning sign that something is wrong with your welder.
- e. Have the welder installed by an electrician.
- f. Before opening your welder disconnect the power by either unplugging the welder or turning off the **power disconnect switch**.

Secondary voltage shock (60-100V) happens when a part of the welding circuit, like a bare spot on the **electrode cable**, and the grounded piece of metal you are welding are touched by parts of your body at the same time. To avoid a secondary voltage shock you should:

- a. Wear dry gloves without holes.
- b. Avoid touching electrodes and the metal parts of electrode holders with skin or wet clothing.
- c. Keep dry **insulation** (a.k.a. the proper protective clothing) between your body, the ground and the metal being welded.
- d. Do not work in wet conditions or where spills are present.
- e. Check electrode holder and cables for damage and have any damage repaired before using.

A few other things you can do to avoid electrical shock are to never weld on **live circuits**, be sure the **ground clamp** is securely fastened to the welding table or metal being welded and never set the electrode holder on the welding table or in contact with any grounded metal.

Hot Tip

Damaged cables can be repaired with electrical tape.

11. **Read and obey warning labels.** Dangerous materials will be marked with symbols to let us know of their potential hazards. In Canada, this labelling system is called **WHMIS** (Workplace Hazardous Materials Information System). It is important to be able to identify WHMIS symbols and know what they mean so that we can safely handle dangerous materials.

The following are standard WHMIS symbols:

Compressed Gas



Compressed gases are materials that are gases at normal room temperature and pressure, but that are packaged as pressurized gas, dissolved gas or liquefied gas by compression or refrigeration. Containers holding compressed gas need to be kept away from heat and handled carefully. The gases are held under high pressure and the container may explode if heated or dropped or become a projectile object when ruptured. Examples

of compressed gases that you may find in a welding shop are acetylene and oxygen tanks.

Flammable and Combustible Material



Flammable or combustible materials are capable of catching fire easily when exposed to a flame, spark or other source of ignition (like friction). The materials may be solids, liquids or gases and in the welding shop include things like acetylene, grease and paints.

Oxidizing Material



Fires always need three things to start: fuel (a combustible material), an ignition source (heat, spark, friction, etc.) and oxygen. Oxidizing materials increase the rise of fire or explosion if they come in contact with flammable or combustible materials because they release oxygen or other oxidizing materials. Some examples of oxidizing materials are hydrogen peroxide and compressed oxygen.

Poisonous and Infections Material – Materials Causing Immediate and Serious Toxic Effects



These materials can cause death or injury when a person is exposed to even small amounts, through inhalation or skin contact. Some examples of these poisonous materials are sodium cyanide and hydrogen sulphide.

Poisonous and Infections Material – Materials Causing Other Toxic Effects



With repeated or prolonged exposure these materials can cause life-threatening and serious long-term health problems, like cancer or reproductive problems. They can also cause less severe but immediate reactions like eye and skin irritation. Some examples of these poisonous materials are mercury and acetone.

Poisonous and Infections Material – Biohazardous Infectious Material



These materials contain pathogens (disease causing organisms) that have been shown to cause serious disease resulting in illness or death. Some examples of these poisonous materials are a culture containing salmonella and a blood sample containing Hepatitis B.

Corrosive Material



These materials can eat through metals and permanently damage human tissue on contact. They may also be harmful to inhale. Some examples of corrosive materials are ammonia and hydrochloric acid.

Dangerously Reactive Material



These materials are very unstable. They may self-react (explode) when exposed to things such as an increase in temperature, physical shock or friction. They may also react with water to release toxic or flammable gases. Some examples of reactive materials are ozone and benzoyl peroxide.



ACTIVITY

#11. WHMIS I.D.

You may be thinking that this is a lot of safety information. But when we go out in the shop and start welding it's important that we remember to stay safe so that we don't hurt ourselves or others. This means constantly being aware of the possible dangers and following the rules. If your leader has any safety guidelines for the shop beyond the ones listed here, be sure to follow them as well. Remember, arc welding is a safe activity if we know the dangers, follow safety rules and use common sense.



ACTIVITY

#12. Rules of the Shop



#13. Safety Video



#14. Team Tent Building

CHAPTER 5: Tools of the Trade

Now that we know all about welding safety, it's time to get familiar with some of the tools we'll use and see around the shop.

Angle grinder – This is a hand-held power tool that can be used to clean metal before welding and to shape the edges of metal pieces.



Chipping hammer – These hammers are used to chip off slag from the weld before passing another weld over it. Some of these hammers come as a brush/hammer combo.



Wire Brush – These stiff wire brushes are used to clean welds once the slag has been chipped off. They can also be used to remove rust, paint, etc. before welding.



Soapstone – This is like chalk, except it won't burn at high temperatures. An area marked with soapstone is easier to see through a welding helmet. So if you're having trouble seeing the spot you need to weld, make it with soapstone. It will really help!

Water bucket – This is used to dip hot metal in so that it cools quickly. You'll want to do this with your practice pieces so that you don't have to wait for the metal to cool down to keep working. But, quenching metal in cold water like this destroys some of the metals desirable qualities. So you do not want to do this with any of your actual welding projects.

Pliers – You'll need to have a pair of pliers with you to pick up hot pieces of metal.



Tape measure and framing square – These tools will be needed when working on your projects to ensure that you have the correct measurements and that you are welding your pieces together at the correct angles.



Welding table – This is a metal table where you'll do all of your welding. Most are made of a thick steel plate, but if the table is made of copper or cast iron, welding spatter won't stick to it.

C-clamp – This clamp will come in handy when you need to hold two objects in place to be welded.



Fixed clamp – Many welders attach these clamps to a vertical pipe that is fixed to their welding table. The clamp can then hold their work in position.

Can for metal scraps – This is a safe place to put scraps. The can must be made of metal so that if scraps are still a bit hot, no fire will start.



Most of these tools will already be found in the welding shop. If you need to bring any of your own tools to the meeting, your leader will let you know.



ACTIVITY

#15. Shop Tour



#16. Bottle Toss

Unit 1 Resources

http://www.weldinginfocenter.org/basics/ba_02.html

<http://www.aws.org/technical/facts/>

<http://www.weldinginfocenter.org/health/index.html>

<http://www.lincolnelectric.com/en-us/education-center/welding-safety/Pages/welding-safety.aspx>

<http://www.worksafesask.ca/Hazard-symbols-classes>

www.health.gc.ca/whmis

<http://www2.worksafebc.com/Topics/WHMIS/Introduction.asp>

COMPLETE LIST OF UNIT 1 ACTIVITIES



#1. Meet, Greet and Goals



#2. Here a Weld, There a Weld, Everywhere a Weld



#3. Chocolate Welding



#4. Finding Metal for Projects



#5. Parts of a Helmet



#6. Types of Helmets



#7. The Good and the Bad



#8. The Right Gear



#9. Gear Guide



#10. At the Store



#11. WHMIS I.D.



#12. Rules of the Shop



#13. Safety Video



#14. Team Tent Building



#15. Shop Tour



#16. Bottle Toss

Unit 2

All About Arc



Bring with you to the meeting:

- Pen or pencil and notebook
- Clothes to weld in and safety gear (see appendix for the image of the well-dressed welder)

In this Unit we will:

- Look over some common words used by welders.
- Take a quick look at the history of welding.
- Find out how shielded metal arc welding works.
- Learn how to set up the welding circuit and strike an arc.
- Make a list of clean-up duties that needs to be done at the end of the day.

CHAPTER 1: Talk the Talk

If you want to be a welder, you not only have to dress and act safely like one, you also need to talk like one. Most trades and professions have a unique set of words when communicating about their jobs, and welding is no exception. Becoming familiar with the list of “welding words” below will help us as we learn about arc welding in the following chapters.

Current – the movement or flow of an electrical charge through a **conductor**.

Welding circuit – the electrical path in welding where the current flows: from the power source through the components and connections that make up the circuit and then back to the source. The welding circuit consists of the welding machine (the power source), the electrode cable, the electrode holder, the electrode, the arc, the base metal, the ground clamp and the ground cable.

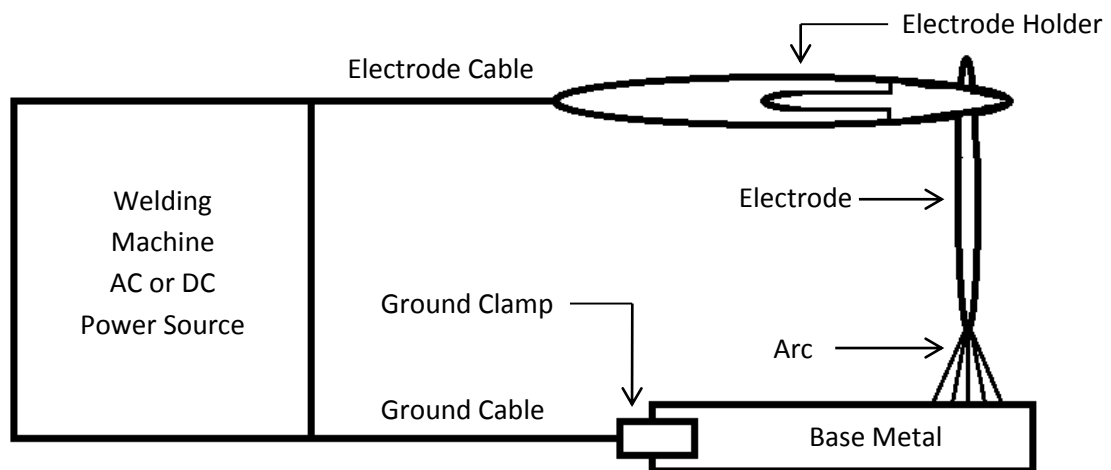

Amperage – the amount of electrical current that flows through a circuit. In welding, when you adjust the amperage or “amps” you adjust the amount of heat that you are welding with.

Direct current (DC) – an electrical current that flows in one constant direction, either from positive to negative or from negative to positive.

Alternating current (AC) – an electrical current that constantly reverses its direction between positive and negative at regular intervals.

Welder or welding machine – the machine (that can confusingly share the same name with the person that is operating the machine) which provides a power source to carry out welding operations.

Duty cycle – the number of minutes, usually during a 10-minute cycle period, that the welder can be operated at maximum output without needing to cool down. It is usually given in a percentage. For example, 30% duty cycle means that the unit has the capability of operating at maximum output for three minutes of each 10-minute period before the welder needs to cool down.

Base metal – the metal or alloy this is being welded. Also referred to as the **workpiece**.

Ground clamp – the clamp that must be attached to the metal being welded (the base metal) or to the welding table in order to arc weld.

Ground cable – a flexible, durable and well insulated cable attached to the ground clamp used to move current back to the welder. Also called **work lead** or **ground lead**.

Electrode – also called **welding rods**. These are the long metal rods, comprised of a wire core and a flux covering. When the electrode is part of the welding circuit the arc is created between its tip and the base metal. The heat of the arc cause the electrode to melt providing the filler material needed to fuse metals together in arc welding.

Flux – the coating found on the outside of the electrode, covering the core wire of the electrode. When the flux melts it produces **shielding gas** to protect the weld and then forms a hardened protective coating over the weld, called slag.

Electrode holder – the insulated hand clamp used to hold the electrode during welding. The electrode holder conducts current into the electrode. It is also commonly referred to as the **stinger**.

Electrode cable – flexible, durable and well insulated cable used to move current from the welder to the electrode. It is also called **electrode lead**.

Arc – the physical gap between the end of the electrode and the base metal where heat is generated. The heat is caused by the flow of electricity through the gap (due to resistance of current flow and arc rays).

Weld pool – also called **weld puddle**. This is the area of the base metal which has reached its melting point and has become a pool of hot liquid metal. It is normally about the size of a dime.

Arc length – the distance from the tip of the electrode to the adjacent surface of the weld pool.

Bead – the metal that has been added in welding. It is this continuous deposit of weld metal that creates the seam between the two pieces of metal that have been fused together.

Slag – the waste material left on the weld bead that must be chipped off. Is a nonmetallic waste product created by the flux.

At first, reading through this list of terminology may feel like you're reading a foreign language, especially if you've never welded before. But, don't worry. Once we get out in to the shop and start welding, you'll begin hearing these words being used in context. And, eventually they will begin to feel like common place. Soon you'll be adding more words into your "welding language" and will be speaking like a welder in no time. Remember that these words, and all other welding terms that you'll need to know for the arc welding, are found at the back of this Reference Manual.

ACTIVITY



#17. Learn the Lingo - Crossword



#18. Learn the Lingo - Wordsearch



#19. Learn the Lingo – Word Match

CHAPTER 2: A Very Brief History

Humans started working with metals a long time ago (more than 6,000 years ago) and have actually been welding metals together for quite a while as well (for more than 3,000 years.) However, the method they used to weld for thousands of years was fairly primitive. They used a *forge* to heat the metal and then hammered it together until it fused.

It wasn't until relatively recently (200 years ago) that humans began to discover a more efficient way to fuse two pieces of metal together. Despite that, would you believe that the first cars built in the early 1900s were bolted together, not welded? This is because even though electric arc welding began to be developed more than 200 years ago, it wasn't used successfully in industry until about 1910.

In 1782, a professor in Germany made the first known electric arc weld. Then in 1801, in England, Sir Humphrey Davy made the first sustained arc weld. But, the first time that someone intentionally joined pieces of metal together with arc welding wasn't until 1860, by an Englishman named Wilde. Throughout the rest of the late 1800s and beginning of the 1900s various advances were made in arc welding to improve the process. It wasn't until the demands for products that came with World War I that arc welding became prevalent in industry.

Since then, arc welding has continued to be developed and is still the most widely used type of welding. In fact, there are more than 20 different arc welding processes being used today. In this project, we are going to work with the arc welding process that is the most common. It is called **SMAW**, which stands for shielded metal arc welding. It is often referred to as *stick welding*, *electric arc welding* or simply just as *arc welding*.

Spark of Information

All of these different arc welding processes use the same three principles to fuse metal. They all use a heat source, a filler material and a type of shielding.

SMAW is a great place to start learning how to weld because the skills that you develop can be transferred to all other types of welding. Plus, SMAW machines are quite accessible because of how mainstream they are. You'll find them on farms, in small welding shops and in various welding industries.

CHAPTER 3: How It Works

The Process

All types of arc welding require three things to weld metal. They all require a heat source, a **filler material** and a type of shielding. And so, of course, shielded metal arc welding is no exception.

In SMAW, heat is generated when the arc is struck. And by heat we're talking about 3,600°C! As a welder, you're responsible for creating this heat by keeping a small amount of space between the electrode and your workpiece. This creates a gap in the electrical circuit. When electrical current jumps across this gap, it creates the arc, and thus the heat.

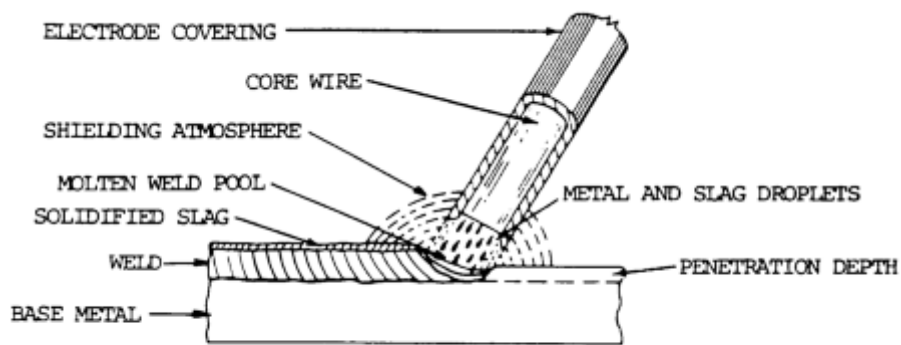

SMAW PROCESS

When the arc is struck, the heat that is generated begins to melt the base metal, creating a molten puddle. The force of the arc also creates a **crater** in the base metal. You can picture this crater being formed in the way that the force of water from a garden hose makes ruts in dirt as you drag it along the ground.

At the same time, the end of the electrode is also melted and the particles of molten metal pass through the arc stream into the molten puddle. This is the filler material that builds up forming the weld bead. As the electrode adds material to the weld it is used up, and so becomes smaller and smaller.

The flux coating on the electrode is also melted by the arc. When this happens, gases are released which shield the weld puddle from the surrounding atmosphere. (Gases in the atmosphere can ruin a weld.) Other parts of the flux coating also pass through the arc stream into the molten puddle. They then float to the top of the weld puddle, creating a protective covering over the weld bead called slag. As the welder, you create a continuous weld bead by moving the arc along the workpiece.

The result of all of this is the *fusion* of two different pieces of metal into one strong piece.

Of course, for all of this to happen we need a power source to create the heat, as well as all of the components that create a welding circuit.

The Machine

When unplugging an electric plug from a wall socket, you sometimes see a spark jump from the end of the plug into the socket. That spark is the electricity trying to keep its movement going. If you keep electricity jumping a small gap like this it will produce a lot of heat.

Shielded metal arc welding is often called electric arc welding because it produces its heat like this, with electricity. When the electricity jumps from the small gap between the electrode and the metal being welded the heat producing arc is created.

The power source that produces this electricity is the welding machine*. The machines we're using need to be plugged into an electrical outlet. And not just into any outlet. The outlet needs to be on its own circuit, with a power disconnect switch and specially wired to provide the correct voltage for the welder being plugged in to it. Most welders found on farms and in shops are 220V. This is enough voltage to carry out all of their welding needs. Welders using a higher voltage exist, but are mainly used in industry.

No matter the type or style of welder, all electric arc welding machines produce a steady flow of electrical current with relatively low voltage and high amperage. They are known as *constant current machines*. This means that the current stays at fairly constant amperage, despite changes in arc length.

These machines either produce an alternating current (AC) or a direct current (DC). Some SMAW machines are AC/DC, meaning they have both AC and DC capabilities, allowing you to switch between the two currents.

Hot Tip

You should never intentionally try to create a spark like this at an electrical socket. It could start a fire.

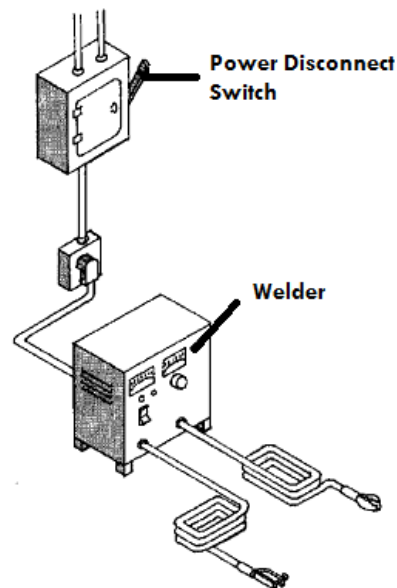

*There are many different types of SMAW welders available that produce their electricity in different ways. It's most likely that you'll be using a 220V that plugs into the wall, so that's what we'll talk about here.

The current in AC welders changes its direction of travel several hundred times per minute. Whereas, with DC welders, the current always travels in the same direction. With DC machines you are also able to choose which direction you want the current to travel (either by flipping a switch or changing around cables). The two different directions of travel are called DC+ or DC-. When welding, these different types of currents, AC, DC+ and DC-, all behave slightly differently from each other.

It might make a difference to a professional which of these currents is used. But, for general welding, and the type of welding that we'll be doing in this project, any of these will work just fine. In Unit 4, we'll learn more about currents, **polarity** and amperage. You'll discover then when you might prefer to use one type of current over the other.

The benefit of having a combination AC/DC machine is that you have the ability to weld with either alternating or direct current. This can come in handy for special welding jobs. You may also find out that you prefer to use one current over the other because of how it handles. For example, because of the current travelling in one constant direction, controlling the arc can be easier with DC.

What's really important with SMAW welders is the duty cycle and the amount of amperage a machine is capable of producing. That's why every welder is rated according to these two things; amperage capacity at specified duty capacity. Welders range from 150-1,000 amps and 20-60 per cent duty cycle.

The duty cycle is the number of minutes, during a 10-minute period, that the welder can be operated at maximum output without needing to cool down. It is usually given in a percentage. For example, 30% duty cycle means that the welder has the capability of operating at maximum output for three minutes in a 10 minute period.

A machine that is rated as 150-300 amp at 20-30 duty cycle is more than adequate enough for farms and home shops.

Regardless of all of this (current used, amperage produced and duty cycle percent), all SMAW machines have the same standard features. They all have a way for you, the welder, to adjust the amperage and see what the amperage is set at. They also all have two terminals, one to attach the ground cable to and one to attach the electrode cable to. And of course, they all have an on/off power switch. In addition, if it's an AC/DC machine it will also have a polarity switch, which allows you to switch between the currents.

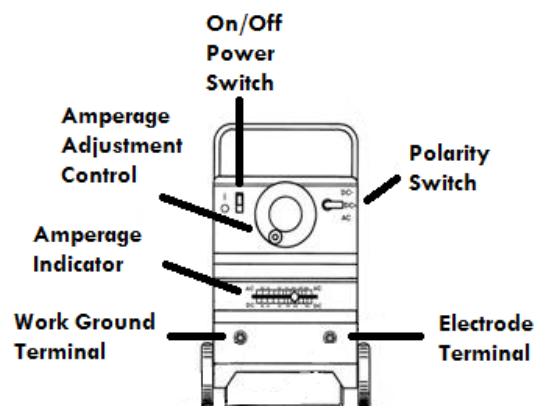

The Welding Circuit

The welding machine is only one of the many parts that make up the welding circuit. If you want to get out there and start welding, you need to be able to properly put together the circuit that will enable you to do just that. Your welding set up should look something like this:

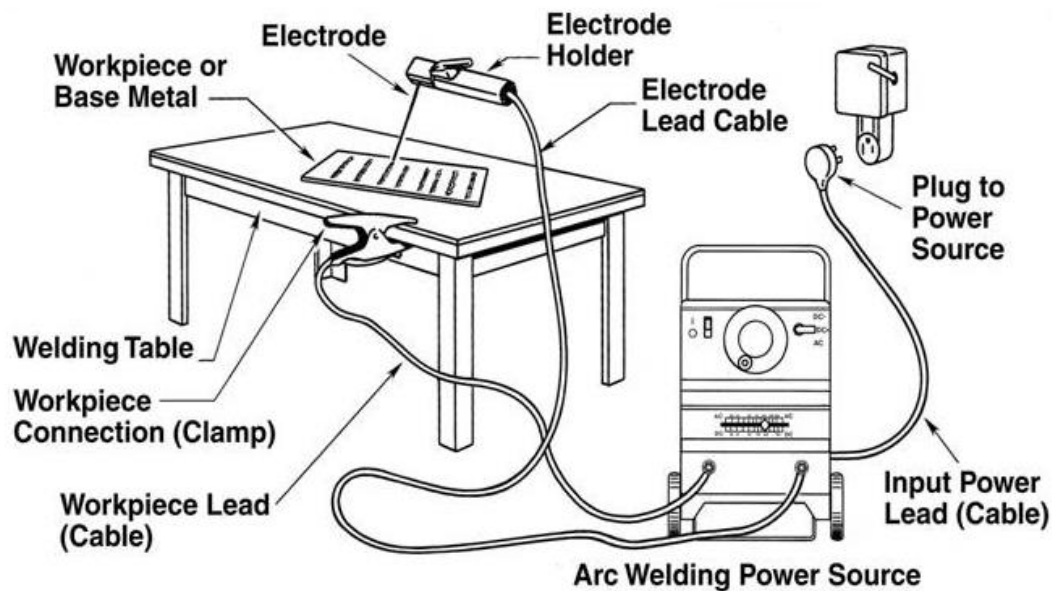

To create the welding circuit, first the cables connect to their proper terminals on the welding machine. These cables carry the current to and from the machine and the metal you're welding. They come in different sizes, according to how much current they can carry without overheating. A No. 4 is sufficient for small shops and farms.

At the end of one of those cables is the ground clamp. This cable is called the work lead or ground clamp. It attaches to the work terminal on the welder. The ground clamp attaches to your workpiece or the welding table (which your workpiece is sitting on). This clamp and cable take the current back to the welder.

The other cable that attaches to the welder is called the electrode lead or electrode cable. It carries electricity from the welder to the electrode holder that it's attached to. The electrode holder is an insulated clamp that is electrically hot. It does exactly what its name implies. It holds the electrode, which is the next part of the welding circuit.

To complete this circuit you turn the machine on and then hold the electrode far enough away from the metal you're working on to sustain an arc. And just like that a weld can be formed!

It's important to keep all the parts of this circuit in good condition. This means dry and free of oil and grease. And if any of the parts are damaged in any way, they need to be replaced.



ACTIVITY

#20. How it All Comes Together



#21. Name That Part

CHAPTER 4: Let the Sparks Fly

Now that we have a basic understanding of how arc welding works, it's time to start welding.

Here are the steps to get yourself set up so that you can begin welding:

1. Prepare the metal you'll be working on. It must be free of dirt, paint, oil, grease and rust. You can remove these contaminants with a wire brush or grinder. Place the metal on the welding table, making sure that the table is clean and that the metal is in good contact with it.
2. With your welder off, check that your equipment is in good working order, that everything is properly connected and that your work space is safe. Are the electrode holder and welding cables in good condition? Are there any dangers in your area that need to be removed (flammables, etc.)? Is the machine grounded and dry?
3. Set up the welding machine and circuit. Connect the ground clamp securely to the metal you're working on or to the welding table. Select the appropriate electrode and set the machine to the correct amperage. (For now, your leader will tell you which electrodes and amperage setting to use.)
4. Make sure that you wearing all your appropriate welding safety equipment (see appendix for the image of the well-dressed welder) and then turn the welder on.
5. Put the electrode securely into the electrode holder. To do this you squeeze the electrode holder to open the jaws and then insert the bare end of the electrode into it. (The bare end is the end without any flux coating on it.) For now, position the electrode so that it is 90° to the holder. Once the electrode is in the holder, be careful not to accidentally touch any metal with it. (This can create an accidental arc.)
6. Get yourself in a comfortable position, flip your welding helmet down, strike an arc and begin welding.

The Welding Circuit

Of course you can only do this last step if you know how to strike an arc! There are actually two different ways to strike an arc. You can either use the tapping or the scratching technique.

If using the scratching technique, scratch the tip of the electrode across the workpiece. Do this just like you would strike a match. Immediately lift electrode slightly after it scratches the surface of the workpiece to start the arc. If the arc goes out, the electrode was lifted too high.

If using the tapping technique, hold the electrode vertically and bring it straight down so the tip of the electrode touches the workpiece. As soon as the electrode touches, lift it slightly to start the arc. If the arc goes out, the electrode was lifted too high.

Whichever technique you choose to use, the important thing is to bring the electrode tip into contact with the base metal and then instantly raise the rod.

For an arc to form, the distance you'll raise the electrode once it contacts the base metal is about 4-5 mm. Once you establish an arc by holding it at this distance for a second or two, you'll bring the electrode tip closer to the base metal to do your welding. (About 1.5-3 mm away.) You'll hold the electrode in place here until a weld puddle forms (a pool of molten metal) that is about the same diameter as two electrodes wide.

And voila... with sparks flying, you'll be welding!

If the electrode gets stuck to the base metal don't panic. This is a common occurrence when learning how to properly strike an arc. (And can happen to veteran welders on occasion.) It even has a special name called "**freezing**" and it's a quick fix to get it unfrozen.

While the electrode is still in the holder, use a sideways wrist snap, to give it a quick twist to get it free. (Leave your helmet down because when it comes free it will flash.) If this doesn't work, release the electrode from the electrode holder and work free with hands. (You can take your helmet off to do this since the electrode is no longer part of the welding circuit.) If you need to use pliers or a chipping hammer to get it free make sure you **SHUT YOUR MACHINE OFF** first.

Don't get discouraged if your electrode gets stuck repeatedly to your workpiece. Everyone sticks the electrode to their workpiece when they're learning. In fact, that's how SMAW gets one of its common nicknames, stick welding. I bet you thought that name came from the electrode looking like a little stick. But no, that's not why. It's because, when learning, the electrode sticks to the workpiece so much!

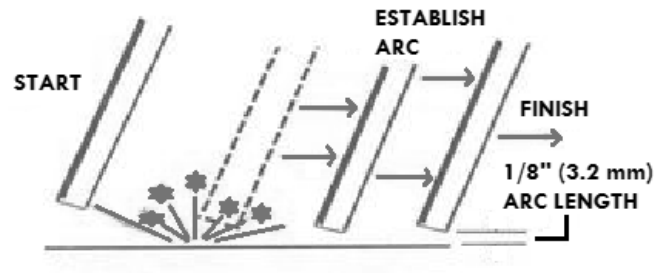

Scratching Method

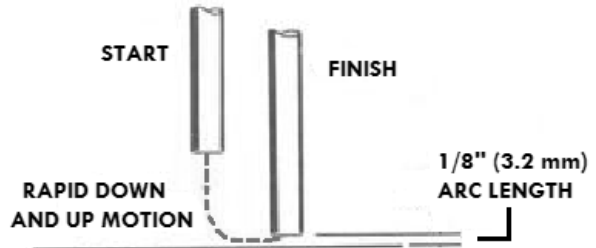

Tapping Method

Troubleshooting

If you're having troubles striking an arc, make sure that the ground clamp is making a good connection with the welding table or base metal. It may help to move the clamp closer to where you're working, or actually attach it to the base metal.

Check that the electrode is clamped in the electrode holder properly. None of the coated part of the electrode should be touching the holder, only the bare metal part of the electrode should be.

Double check that you've set your machine to the correct amperage (the one your leader had you set it at). If your amperage is too high or two low it could make sustaining an arc tricky.

Try welding with both hands. Using both hands to weld helps to steady the electrode and will help with fatigue. To use both hands (assuming you're right-handed) you would rest your left elbow on the welding table. Then, use the left hand to steady the right hand by holding the right wrist. And, if you're left-handed, you would do the opposite.

Try getting yourself in a more comfortable position and relax. If you're not comfortable, you're in for a long day

And most importantly, if you are having difficulty, don't get frustrated. It is common for beginners to have trouble getting the arc going, their hands to be shaking the electrode all over the place, to have the electrode repetitively get stuck to the base metal and to find it difficult to see what they're doing through the helmet lens. Your leader is there to help you. Plus, like most things, welding takes practice. With patience, you will get the hang of it!



ACTIVITY

#22. Striking an Arc



#23. Connect the Dots

CHAPTER 5: Cleaning Up

At the end of each welding day it's important to clean up. Cleaning up properly helps prolong the life of your equipment and insures safety for you and other using the shop.

The following is a checklist to use when cleaning up at the end of the day. Have your leader add any clean-up duties that are missing and check this list at the end of each day to make sure you haven't forgotten to do anything.

Clean-up Checklist

- ✓ Remove the electrode from the holder.
- ✓ Place the electrode holder in a safe spot.
- ✓ Roll up cables.
- ✓ Sweep debris off welding table and floor
- ✓ Disconnect welder from its power source.
- ✓ Place metal scraps that you welded on in metal bin.
- ✓
- ✓
- ✓
- ✓
- ✓
- ✓
- ✓

ACTIVITY



#24. Cleaning-up Duties



#25. Question Toss



#26. Cartoon Safety

Unit 2 Resources

http://www.welding.com/history_of_welding.asp

<http://deltaschooloftrades.com/stick%20welding.htm>

http://www.esabna.com/EUWeb/AWTC/Lesson2_4.htm

<http://www.advantagefabricatedmetals.com/stick-welding.html>

<http://www.mig-welding.co.uk/arc-welder-types.htm>

<http://www.lincolnelectric.com/en-us/support/welding-how-to/Pages/strike-establish-arc-detail.aspx>

<http://www.mig-welding.co.uk/arc-starting.htm> - **includes video** (on right hand side of page)

http://www.ehow.com/video_4420307_strike-arc-arc-welding.html - **video**

COMPLETE LIST OF UNIT 2 ACTIVITIES



#17. Learn the Lingo Crossword



#18. Learn the Lingo Wordsearch



#19. Learn the Lingo Word Match



#20. How it All Comes Together - Mandatory



#21. Name That Part



#22. Striking an Arc - Mandatory



#23. Connect the Dots



#24. Clean-up Duties - Mandatory



#25. Question Toss



#26. Cartoon Safety

Unit 3

Ready, Set, Weld



Bring with you to the meeting:

- A pen or pencil and notebook
- Clothes to weld in and safety gear (see appendix for the image of the well-dressed welder)

In this Unit we will:

- How to form a weld bead.
- Examine the different techniques used to create a well formed bead.
- Find out how to restart and finish beads.
- Take all of this new information and put it to practice in the shop.

CHAPTER 1: Running a Stringer Bead

In the last Unit, we learned how to strike and maintain an arc. No matter which technique you choose to use to strike an arc (scratching or tapping), the next step is to create a continuous weld bead. Arc welding is all about making one good weld bead at a time. Once we know how to run a bead, we can start welding pieces of metal together. And that means you can start building those projects you have in mind.

There are several different types of weld beads you can make. For now, we're going to learn how to run a **stringer bead**. This may not leave beads that are as aesthetic as ones done by using a circular or zigzag motion (which we'll learn to do in Unit 5), but if done properly they are just as strong. The basic techniques we learn running a stringer bead can be applied to all of the other types of welding beads we'll ever make.

A stringer bead is a narrow bead made by dragging the electrode across the base metal in the direction you wish to make the weld. Or, instead of just using a simple dragging motion, it can also be made by using a stepping motion, which is done by adding a very tiny back and forth motion into the drag. Once the slag is chipped off, a good stringer bead looks a bit like a roll of dimes.

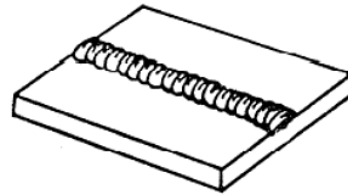

To start running a stringer bead, you'll strike the arc. Once the arc is established, you'll tilt the electrode towards the direction of travel. You'll hold the arc here, at the starting point, for a moment or two, letting it form a proper molten puddle. Then, with some fancy handwork, you'll move the electrode along, creating the weld bead, one molten puddle after another. This is a real game of coordination because, as you weld, you need to continuously move the electrode in two directions at once. Down, as the electrode is consumed by the arc, and across, to lay a continuous, even bead. Right-handed people usually start a weld bead at the left of the weld and then work towards the right. Left-handed people usually do the opposite.

In order to weld, we need to carefully watch the molten puddle. The puddle is the key to producing a good, strong weld. A new puddle is created every time we move the arc a little bit further along the weld. And every new puddle created is just as important as the last. As you move the arc along, you need to watch where each new puddle meets the surface of the base metal to ensure that it is the same width as the puddle before it. You should also be watching the top of the puddle to see that it's building up as high as the puddle before it. Doing this ensures that we end up with a nice bead that is uniform in size the entire way along.

There are other factors that affect how good (or bad) a weld is: amperage, length of arc, **travel speed** and electrode angle. These things all affect the final quality and strength of a weld. But,

how can we be sure if we're doing all of these things properly as we're welding? The molten puddle of course! If we know what to look for, by watching the puddle, we will be able to tell how to adjust all of these things so that our end result is a high-quality, strong weld. Being able to recognize a good weld bead while you're making it is a very important skill to learn. So that's exactly what we're going to learn how to do in the rest of this Unit. We have a lot of information to cover in the next few chapters, but once we finish reading all about proper welding technique, we'll get to learn to do by doing by getting out into the shop and putting all of this knowledge into practice.

CHAPTER 2: Arc Length

Correct arc length is something you discovered when you were striking an arc. You may have found that if your electrode got too close to the base metal it got stuck. Or, that if your electrode got too far away, the arc went out. These things happened because of arc length; the distance between the tip of your electrode and the base metal. The closer your electrode tip gets to the base metal, the shorter the arc length is. The farther away it gets, the longer arc length is.

Somewhere in between being too close and being too far away is the sweet spot where the arc is sustained. A sustained arc isn't the only indication that you are welding with the correct arc length. Even with an established arc, you can still have an arc length that is too short or too long.

If the arc length is too short, the tip of the electrode is too close to the base metal. The arc will not create enough heat to properly melt the base metal or the electrode, and the electrode will frequently stick to the base metal. This leads to poor **penetration** and ill-shaped beads. Beads produced with short arc length may have irregular shape and ripples, a high crown and could have slag trapped in them.

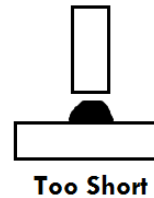

If the arc length is too long, the tip of the electrode is too far away from the base metal. This can cause the arc itself to jump around which leads to poor penetration and fusion, and you lose control of how the filler metal is deposited. Metal melts off the electrode in blobs and are blown around by the arc force. Beads produced with long arc length may be uneven, wide and flat, and have excessive spatter. The slag may also be difficult to remove, especially from around the edges of the weld, and they may have **undercut** or **porosity**.

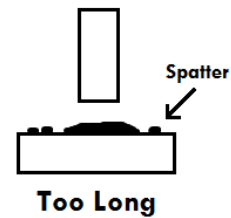

The correct arc length helps control the puddle, so that you can produce uniform weld beads, with consistent penetration. That means that the better you control arc length, the better quality your welds will be. Besides watching the puddle for proper arc length, you can also listen for it. When the proper arc length is obtained, it produces a sharp, crackling sound, sort of like bacon frying. If arc length is too long, this turns into more of a hissing sound, sort of like steam is trying to escape. Most beginners tend to weld with an arc length that is too long.



It can be tricky to maintain the proper arc length because as the weld puddle is formed the electrode adds filler material to the puddle. This causes the electrode to become shorter and shorter, and the tip to be further and further away from the base metal. This means that you

need to continuously move the electrode closer to your work piece to constantly maintain the correct arc length. All of course, while moving the electrode in the direction you wish to make the weld bead.

When you strike an arc, in order for it to establish, you need to hold the electrode 4-5 mm away. This distance is considered an excessively long arc length. (This is why you need to bring the electrode closer to your workpiece once the arc is established.)

A good rule of thumb, to help you find the correct arc length, is that the length of arc should be about the same diameter as the core wire in the electrode you're using. This means that if you're using an electrode with a thicker core wire, the correct arc length will be longer. And if the core wire is thinner, the correct arc will be shorter. That being said, the correct arc length will vary with things like the material being welded, the **welding position** and the type of electrode being used. Sometimes, the correct arc length can even be so short that the flux coating of the electrode touches the workpiece as you weld.

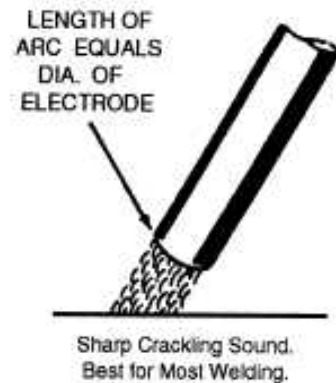

ACTIVITY

#27. Good Weld Cheat Sheet – Part 1

CHAPTER 3: Electrode Angle

The next step to making proper welds is to hold the electrode at the correct angles. Electrode angles greatly affect the shape of the weld bead. There are two different electrode angles we need to be aware of: the **travel angle** and the **work angle**.

Hot Tip

A 90° angle is the same as “square” or “perpendicular.”

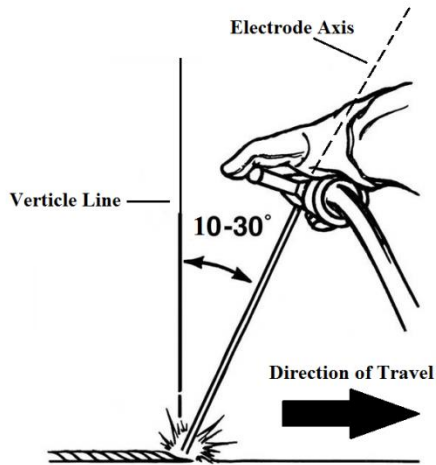

TRAVEL ANGLE

If you hold your electrode on the weld line and then look from one end of your workpiece to the other along the weld line, the side to side tilt of the electrode off of this weld line is the work angle. When we hold the electrode perfectly in line with the weld like this, the work angle is 0°. For laying our stringer beads, we want a work angle of 0°, keeping the electrode in line with the weld we're running.

Electrode angles matter so much because of the arc force at the end of the rod. When we learned how SMAW worked, we found out that the force of the arc is so strong that it creates a crater in the base metal. This arc force also has another purpose. It helps us manipulate the puddle. If we hold the electrode at the proper angle for the job being done, the arc force can help us get the puddle doing what we want it to do.

When the rod is held straight up and down, all the heat is concentrated right under the rod and the arc force drives the puddle down. This results in deep penetration and spreads the puddle out, creating a flatter weld bead and less weld build up. As the rod is angled, the arc force is

The travel angle is the tilt of the electrode in the direction of the weld. To achieve this angle, hold the electrode at a 90° angle to the workpiece. Then, tilt it slightly towards the direction you will be travelling to run your bead. However much you tilt the electrode from its original 90° position, is considered the travel angle. For the stringer beads we will be welding, we want our travel angle to be around 10-30°. (This means that the angle between your electrode and the workpiece will be 60-80°.)

If you hold your electrode on the weld line and then look from one end of your

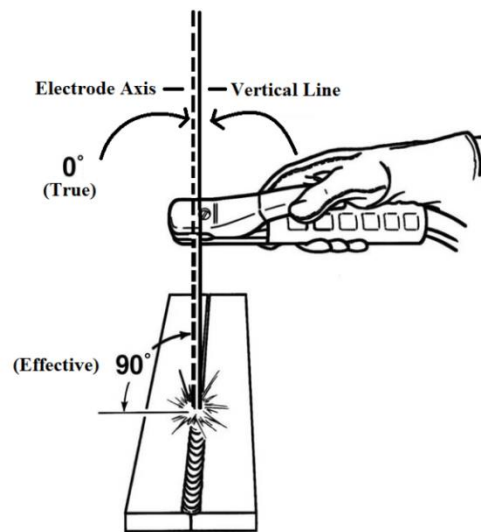

WORK ANGLE

directed more towards the back of the puddle, allowing the weld to stack up and build. If the rod is angled too low, the arc is directed right where we're trying to build up the weld, making the puddle hard to control.

When we run a stringer bead, we should think of the arc as pushing the puddle towards the bead to create the proper weld, rather than as the electrode dragging the bead where we want it to go. This is why a travel angle of 10-30° works best. You may run into situations where you do want to flatten out the weld, or when you'll need to push the puddle back more. These situations will require using different rod angles than the ones we use to run stringer beads.

It takes a lot of practice to always be able to maintain the correct angle while welding. Being comfortable can definitely help with this. If the electrode isn't sitting in the holder in a way that is comfortable to weld with, there is an easy fix. While the electrode is in the holder, grab it and bend it to a new angle until you find one that makes it more comfortable to hold and maintain the correct angle.

Hot Tip

You should try to use an electrode until only 4 cm remains before replacing it with a new one. Throwing away longer electrode stubs is wasteful. Stubs shorter than this can cause damage to the electrode holder.



ACTIVITY

#27. Good Weld Cheat Sheet – Part 2

CHAPTER 4: Current Setting (Amperage)

In order to do any sort of arc welding, we need enough heat to melt the base metal and form a molten puddle. This heat is controlled by the amount of current, or amperage, we use. The higher the amperage is set, the hotter the arc is. Correct amperage setting is important to ensure a well-shaped bead, proper penetration and a minimum amount of spatter.

If the amperage is set too low, the base metal doesn't get hot enough for proper penetration. This means that molten metal from the electrode lays more on top of the work instead of adequately penetrating the base metal. This can make the weld bead narrow, irregular shaped and cause it to pile up or overlap. The puddle may be smaller and can look a bit like it is following the electrode around rather than the arc pushing the puddle. You can also experience trouble striking the arc and maintaining the correct arc length.

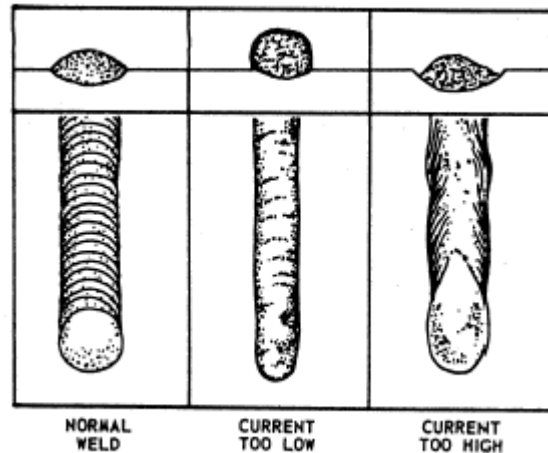

If the amperage is set too high, the base metal gets too hot, causing the strong arc force to gouge too deeply into the base metal. This can make the weld bead flat and porous and have undercutting around its edges. There can also be excessive spatter around the bead and the slag can be difficult to remove from the edges of the weld. The electrode can also become overheated if the amperage is set too high. When this happens you might see charring on the flux coating and the electrode will melt faster. If excessive travel speed is used to compensate for the faster melting electrode, you could end up with slag in your weld, which would be bad. If your amperage is much too high, you could even burn through the base metal!

When the amperage is set just right, the puddle will spread out and its outside edges will tie into the base metal immediately. You should also be able to ease the puddle around, by gently pushing it with the arc force. The bead will be a consistent rounded shape and the slag will be easy to remove. The correct amperage also ensures good penetration by allowing the arc force to form a crater that is the proper depth. This depth is important because it is the distance that the weld can reach into the metal and directly affects how strong a weld will be. A weld with too little penetration will be weak and can come apart with light pressure.

The correct amperage setting will change with the welding job at hand and depends on a variety of things. Thickness of metal being welded, type/size of electrode, welding position and machine being used all affect what the amperage will need to be set at. If a metal is thick, it will need a

higher amperage than a thin metal and a small electrode requires less amperage than a large one. Correct amperage setting is determined by what the molten puddle is doing. You'll know when you've found the right amperage when the puddle is behaving properly. After you gain some experience, this process will become easier and easier. Eventually, you'll develop a good idea of the amperage that different jobs require. Most welding machines also have charts fixed to them that aid in choosing the correct amperage for a variety of electrodes and material thicknesses.

Spark of Information

Every electrode has a range of amperage that it can be used at. (This is given by the manufacturer and can usually be found on the outside of the electrode box.) The electrode will work anywhere within this given range. That being said, when you're trying to pick the correct amperage for the job, start by picking one that is in the middle of the manufacturer's recommended range. For example, if the suggested range is between 75 and 130, start by setting the amperage around 100. Then, once you begin welding, depending on what the puddle is doing, fine tune the amperage, adjusting it up or down.



ACTIVITY

#27. Good Weld Cheat Sheet – Part 3

CHAPTER 5: Travel Speed

Welding has a lot to do with the temperature of the base metal. This is why travel speed plays an important factor in forming a good quality weld bead. Travel speed is the rate at which you, the welder, move the electrode along the weld seam. This speed determines how much the weld bead is built up in height and width.

When you move too slowly, you put heat into the base metal for a longer amount of time. This causes the metal to get extremely hot which will result in poor penetration; the puddle will spread out and be hard to control. The beads produced are too wide and too high and the weld metal will pile up and be an inconsistent shape because of overlap. This overlap can also lead to slag inclusions in the bead that cannot be removed. If you move much too slowly you can also burn a hole right through the base metal.

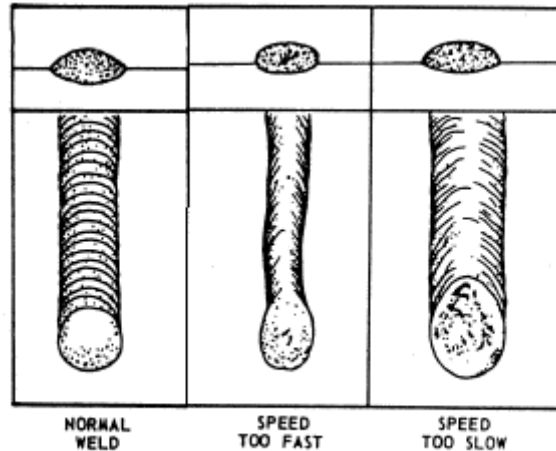

When you move too fast, you produce welds with poor penetration and which are weak and can crack easily. This happens because not enough time is allowed for the base metal to heat up properly, causing the puddle to cool too quickly (which locks in impurities) and makes the weld bead sit more on top of the base metal. The beads produced do not have enough height, are thin and stringy, and have a v-shaped ripple. There may also be undercut along the edges of the weld.

When the speed of travel is correct, the puddle spreads out, but is still controllable. The sides of the puddle tie into the base metal and the ripples in the weld bead are half-moon or crescent shaped. The beads produced will usually be about as twice as wide as the outer diameter of the electrode and about as high as the diameter of the core of the electrode. If you are able to consistently maintain the correct speed, the result will be uniformly shaped beads with rounded ripples that are evenly spaced.

The correct travel speed will change from job to job depending on a number of things like penetration required, position of the weld and type of electrode used. Most beginner welders tend to travel too fast, so while you are learning, concentrate on moving smoothly and uniformly to create beads that are nicely shaped.

There's one more thing you need to keep in mind to form a bead that is uniform in size from start to finish. The temperature of the base metal heats up as welds are made. This means that the metal is much cooler when we first strike an arc than it is when we get to the end of the

weld. Welding on cooler metal results in weld beads that are smaller than beads formed when welding on hotter metals. So, if we moved at the exact same speed from the beginning of the weld to end, the bead would be slightly smaller at the beginning of the weld (since it was welded on colder metal).

In order to keep our beads the same width from beginning to end despite this temperature change, try to let the weld get as wide in the beginning as it will end up being when the metal is hot. This can be tricky to gauge as a beginner, but will become second nature once you've spent more time welding.



ACTIVITY

#27. Good Weld Cheat Sheet – Part 4

CHAPTER 6: Re-starting, Stopping and Finishing

Sometimes a job is interrupted, or your electrode is completely used up before you've finish the bead you're working on. When this happens, a **crater** is left at the end of the bead. Any dip below the surface of the base metal qualifies as a crater. These hollows are created by the arc force and they may not be clearly visible until the slag is chipped off. You never want to leave a crater anywhere in your weld bead. Craters left in your work, not only look funny, but also create a weak point in the weld, so they need to be filled.

Hot Tip

It's okay to leave a crater when laying practice beads, but you never want to leave them when working on an actual welding project or repair. However, if you always fill them on practice beads, your skills will improve.

You fill this crater properly when restarting the bead. To do this, before restarting the arc, chip the slag off the end of the bead and out of the crater and brush clean. Strike the arc ahead of where you left off (just a touch ahead of the crater). Once the arc is established back track through the crater to the end of the interrupted bead. Then, move forward again and continue welding in your original direction of travel. This should effectively fill the crater and make it appear as though you ran one, uninterrupted bead.

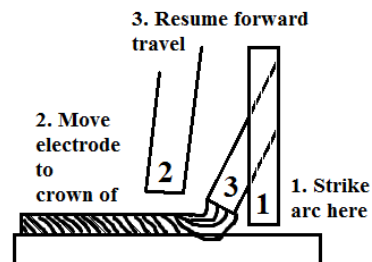

If you stop welding quickly at the end of bead, by quickly withdrawing the electrode, an unfilled crater is also formed. To avoid leaving a crater at the end of your bead you finish it properly by adding a little extra metal to fill the crater before you withdraw the electrode. You can do this by pausing for a moment with the rod at the end of the bead (or by making one or two very tight, tiny circles with the rod at the end of the bead) and then bringing the rod up and back over the weld about 1 cm, before lifting up to extinguish the arc.



Of course, to really see what your finished weld bead looks like, you'll have to chip off the slag with your chipping hammer. Be careful not to look too closely at a hot weld without your welding helmet down. Bits of slag can ping off the weld as it cools. (Hot slag flying at your eye is just another reason to remember to wear your eye protection!)

After you have deposited one weld bead you must properly clean it before you lay another bead. Otherwise, you are just asking for bits of slag to be included in the weld you're making.

This would cause **defects** (like porosity) making weak weld joint. To properly clean a weld, remove the slag with the chipping hammer and then brush it clean with the wire brush. There are other power tools (such as grinders) and chemical agents (such as nitric acid) that can also be used to help clean the weld. If these are available for use in the shop your leader will show you how to use them and what safety precautions need to be taken while using them.

CHAPTER 7: Trying it All Together

Good welds are determined by four things, that you, the operator, can control. These are:

1. Length of Arc
2. Angle of Electrode
3. Speed of Travel
4. Heat (or current/amperage setting)

To help you remember these four things try recalling them by their acronym L.A.S.H.

With practice, and by keeping your eye on the puddle, you'll be able to recognize what looks like a good weld bead, and what doesn't. A good weld bead is slightly higher in the centre, tapering smoothing towards its edges and has evenly spaced ripples all along. It will be consistent in shape and size and there will be a minimal amount of spatter.

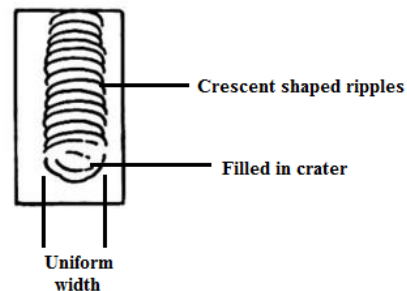

When you're learning, and your weld bead doesn't look like this, it can be tricky to know what exactly you need to change in order to improve the quality of the bead. With a little detective work, you can help identify the problem.

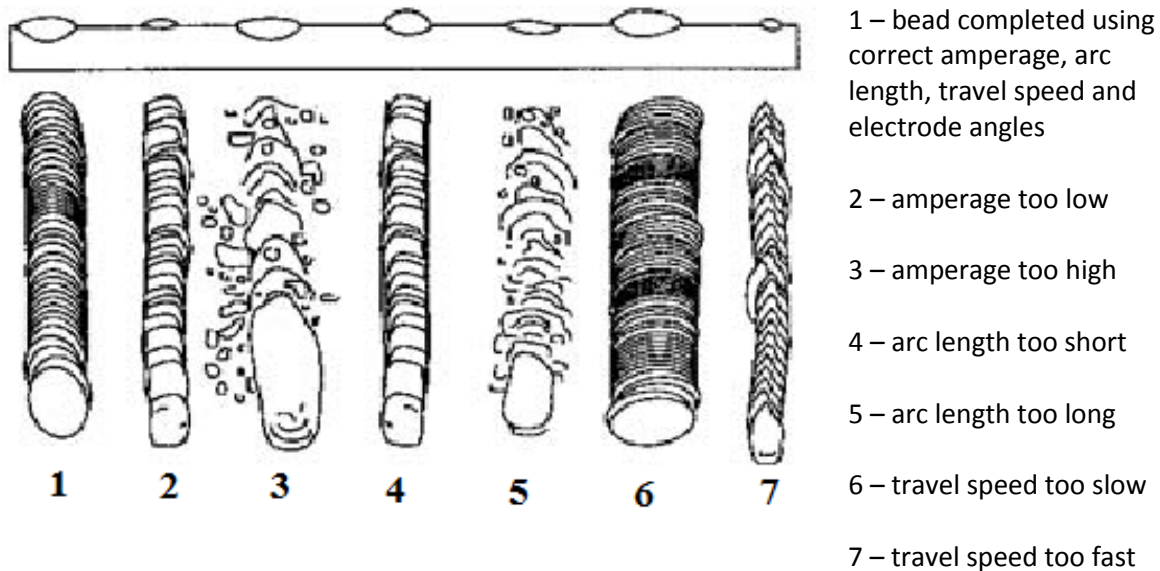

No matter what you're welding the basic steps are all the same. To review, these steps are:

1. Strike the arc.
2. Tilt the electrode in the direction of travel.

3. Wait a moment to allow for a puddle to form and properly penetrate.
4. Begin travelling in the direction you wish to lay the bead.
5. Start the puddle wide enough that it will be uniform with the rest of the weld bead once the base metal heats up.
6. Ease the puddle around using the force of the arc, making sure you always have a good view of the puddle.
7. Watch the sides and top of the puddle ensuring they're the same width and height as the rest of weld bead.
8. Maintain a uniform arc length and speed.
9. If your amperage setting is too high/low stop and adjust it.
10. Add filler metal to the end of the bead before pulling away so you don't leave a crater.

In order to become a proficient welder, two things are for certain. You're going to need to put in a lot of practice time and you are going to make a lot of mistakes. The goal is to learn from our mistakes to develop our skills. So don't be scared of making mistakes, just go for it. The only way you can learn how to make a good weld is by making some bad ones and examining them to see what made them bad. If you're working on a project and you make a bad weld, you can always grind it out and start again. It will take a lot of practice before you'll have the proper technique down and for all of the things we covered in this chapter to become second nature. But it will happen!

ACTIVITY



#27. Good Weld Cheat Sheet – Part 4



#28. See How It's Done



#29. Too Long, Too Short



#30. Tilted This Way or That



#31. Too Hot, Too Cold



#32. Too Fast, Too Slow



#33. All the Wrong Beads



#34. Start, Stop, Re-start



#35. Straight as Can Be



#36. Pad Practice



#37. Written in ~~Stone~~ Metal



#38. Bead Art



#39. How-to Video

Unit 3 Resources

<http://www.mig-welding.co.uk/learning-arc.htm> - **includes video** (on right hand side of page)

<http://www.mig-welding.co.uk/arc-welding-faults.htm>

<http://www.millerwelds.com/resources/articles/index.php?page=articles16.html>

<http://deltaschooloftrades.com/stick%20essentials.htm>

COMPLETE LIST OF UNIT 3 ACTIVITIES



#27. Good Weld Cheat Sheet – Part 1-4



#28. See How It's Done



#29. Too Long, Too Short



#30. Tilted This Way or That



#31. Too Hot, Too Cold



#32. Too Fast, Too Slow



#33. All the Wrong Beads



#34. Start, Stop, Re-start



#35. Straight as Can Be



#36. Pad Practice



#37. Written in Stone Metal



#38. Bead Art



#39. How-To Video

Unit 4

Examining Electrodes



Bring with you to the meeting:

- Pen or pencil
- Notepad

In this Unit we will:

- Talk about how to choose the right electrode for each welding project.
- Learn more about polarity and how it affects the welds we make.
- Find out what electrode numbers stand for.
- Take an in-depth look at five common electrodes.
- Discuss how to prepare metal that will be welded.

CHAPTER 1: Choosing the Correct Electrode for the Job

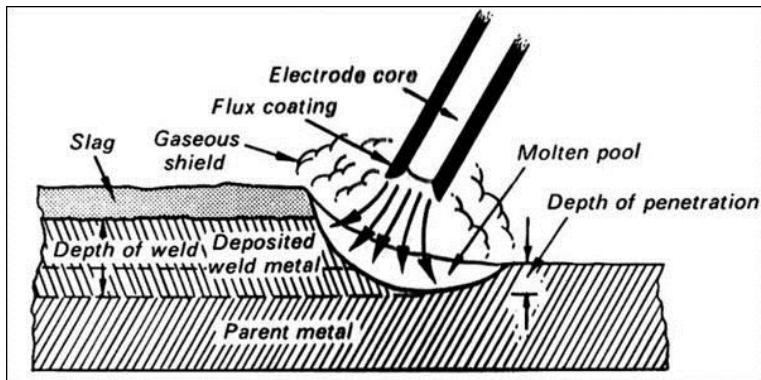

Since we're already running stringer beads we have a pretty good idea of how an electrode works. They contain a core wire and flux coating. The core wire adds filler material to the weld and as the flux burns it protects the puddle with a gaseous shield and deposits slag on top of the

weld bead. But, in order to really be able to call ourselves welders, there is a bit more about electrodes that we need to know. For starters, we need to know how to pick the right electrode for the job. There are several factors that go into choosing the right electrode. Things like type of base metal, metal thickness, current requirements, polarity, welding positions and desired characteristics of the weld all affect which electrode we choose to use.

You can quickly narrow down your choice of electrode options by the type of metal we'll be working with. Electrodes are designed to work with specific types of metals. Since the core wire of the electrode melts as we weld and adds filler material to the weld, a basic rule when picking an electrode is to pick one that contains a metal similar to the one we're working with.

Another factor which affects electrode choice is the thickness of the base metal. Generally, the thicker the metal is, the larger the electrode needed. The size of the electrode is determined by the diameter of its metal core, not by diameter with coating. The diameter is often given in imperial measurements instead of metric. Common **electrode sizes** are 1/8" (2.5mm), 3/32" (3.2mm), 5/32" (4.0mm) and 3/16" (5.0mm). The most common size used in a farm shop is 1/8" and 5/32" to weld metal that is thicker than 6mm. As a basic rule of thumb, the diameter of the electrode should not be larger than the

Spark of Information

Not sure what type of metal you're working with?

Identifying metals properly could be an entire project in and of itself. If you want to try our hand at identifying metals check out websites at the end of this unit under "Resources." You'll find several websites there with tips and test to help you with metal I.D. Most metal we'll be working with in this project will probably be a carbon-steel alloy. But if you do work with another type of metal there is most likely a specific electrode for the job.

thickness of the metal to be welded. Try to choose an electrode diameter that is approximately half of the thickness of the plate to be welded.

That being said, the amperage, diameter of electrode, thickness of workpiece and welding position all co-depend on each other. So it's important to take all of these things into consideration as you set up to weld. For example, higher currents and larger diameter electrodes are better for welding in the flat position than in vertical or overhead positions. And, if you're welding on thinner material you will use a smaller electrode and use less amperage. Thin metals require less current than thick metals, and a small electrode requires less amperage than a large one. Most companies that make electrodes can provide you with charts to help you make these decisions. You can get these charts from your local welding supplier.

CHAPTER 2: Polarity

Polarity is another important factor affecting electrode choice. Polarity is the direction that the current flows in the welding circuit. When we learned about welding machines we talked about the different types of currents, or polarity, SMAW machines can produce: AC or DC (or a machine that is capable of producing both). The AC and DC stand for the way that the current flows. With AC, the current constantly alternates direction back and forth. And in DC, the current always flows in one direction. But, because we choose which direction we want the current to flow, there are actually two different DC currents available to us.

The polarity we use will affect which electrode we choose because some electrodes are designed to work only with specific polarities. We may or may not have a choice of the polarity we use, depending on the machine that we are using. If we do have a choice of polarity, knowing the differences between them can help us decide which one we prefer for the weld we're making.

With AC, the current changes its direction of flow 120 times per second, moving back and forth between positive and negative. When the current changes its direction, the flow, or current, actually stops. AC electrodes are designed with stabilizers in the flux to help maintain and control the arc through these amperage lags. Because of this back and forth motion, heat is distributed evenly between the electrode and workpiece (50% at each). The main advantage of AC is that on machines that can produce either AC or DC, higher amperage can be produced when the machine is using AC.

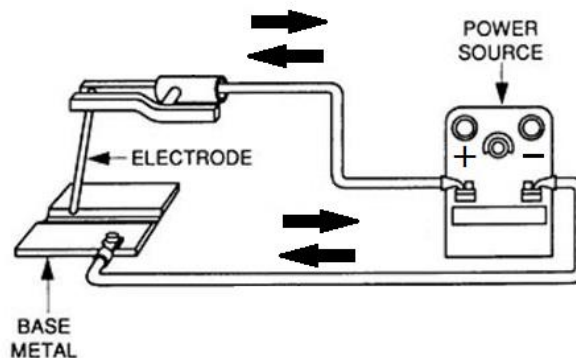

DC, on the other hand, provides a steady flow of current in one continuous direction. DC is better for making out-of-position welds because it is easier to weld with a shorter arc and lower amperage. One disadvantage of DC is **arc blow**. Arc blow causes the arc to wander while you are welding in corners on heavy metal or when using thick-coated electrodes.

There are two different DC polarities available to us because, with every DC machine, you can change the direction of this flow. These two polarities are DC straight (DC-) and DC reverse (DC+). Some machines have a polarity switch allowing us to easily change this direction of flow. On other machines you have to manually change around the leads (cables), attaching them to the opposite terminals. Why would it ever matter to us which DC polarity we use? Polarity

affects the amount of heat going into the base metal. By changing polarity, we direct the heat where it is needed for specific welding jobs.

When the electrode is connected to the positive terminal and the ground is connected to the negative terminal you have DC+ which is often referred to as **reverse polarity** (or **DCEP**: Direct Current Electrode Positive). The current flows from negative to positive. So, with DC+ the arc actually travels from the base metal up into the electrode. This causes the tip of the electrode to heat more than the base metal. In fact, two-thirds of the heat is with the electrode. This gives the operator better control of the arc and often makes DC+ the preferred polarity to use. When using DC+, you'll have deeper penetration, a steadier arc, slower welding speeds and often a narrower weld bead. Because a cooler base metal allows the filler metal to cool faster (giving it greater holding power to stay where it needs to be), DC+ is a good choice when doing overhead welding.

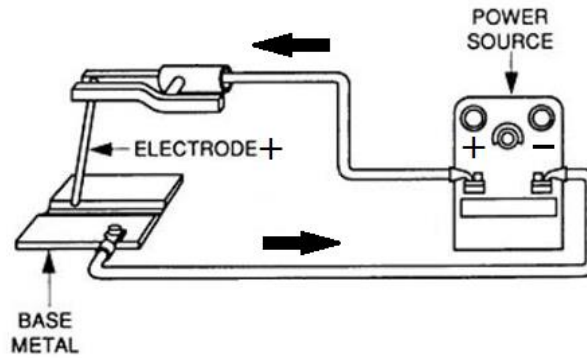

When the electrode is connected to the negative terminal and the ground is connected to the positive you have DC- which is often referred to as **straight polarity** (or **DCEN**: Direct Current Electrode Negative). With DC- the flow is from the electrode to the base metal so the electrode stays cooler and the base metal gets hotter. Two-thirds of the heat is with the base metal. When using DC-, you'll have shallower penetration, faster welding speeds and often a smoother weld bead. DC- is used with certain rods for high speed **sheet metal** welding and in certain situations where it is desirable to have more heat on the workpiece because of its size. DC- is also a good choice when making heavy deposits.

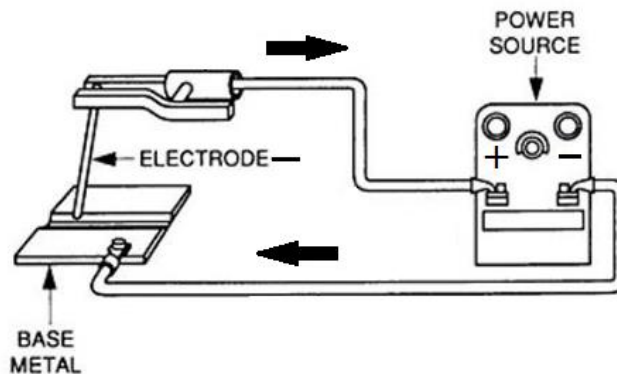

When you're starting out, you most likely won't have a choice what type of machine you use. You'll probably learn to weld with whatever welding machine is put in front of you. So you may not have a choice as to which polarities you can use. Don't worry if the machine you're welding with doesn't have different polarity options. If the machine is in proper working condition, you can weld with it, regardless of polarity, as long as you have the right electrode.

You should be aware that every welding machine welds a little differently. Even two identical machines may have subtle differences in the way that they perform. So, to make things easier, try to use the same welding machine as much as possible. And remember, if you do switch machines, the settings you figured out with one machine may not be exactly the same as ones you need to use with another machine.

CHAPTER 3: Classification

Thankfully, to help welders identify which electrode is best for the job the American Welding Society (AWS) developed a classifications system that is used all across North America. When you understand how this system works, you can tell by just looking at the electrode number (often called **AWS number**) a great deal about the electrode. This number is 4-5 digits long and written right on every single electrode. It tells us the type of electrode, strength of the core wire once welded, type of coating used, welding positions it can be used in, what polarities it will work with and other operating characteristics. Now that's a lot of information passed on from four little numbers!

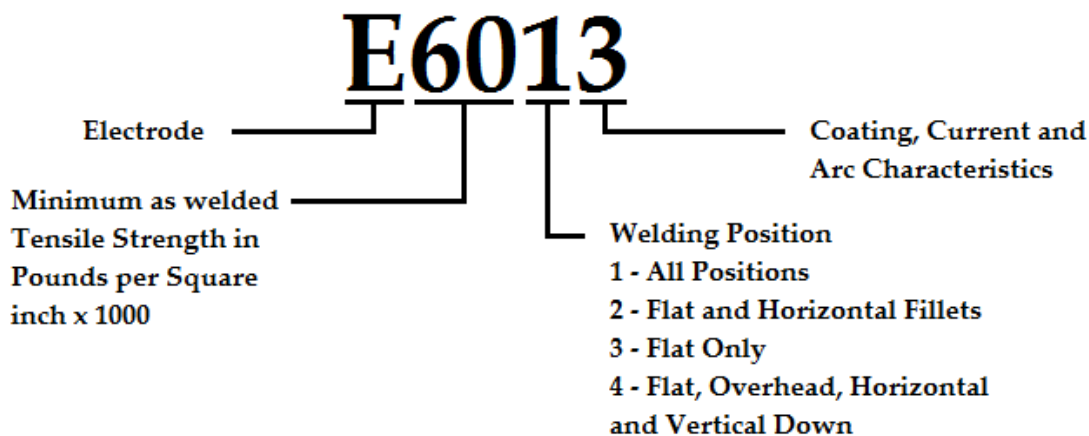

The “E” at the beginning of the number indicates that this is an electrode for electric arc welding.

The first two numbers (E**60**xx) indicate the **tensile strength** of the filler metal. Tensile strength is the force that it would take to pull apart the joint. When you multiply these two numbers by 1,000 you get the minimum tensile strength (in pounds per square inch) of the welded filler metal. For example, if the first two numbers are 60, the strength of the filler metal is 60,000 psi. Some electrodes have a five digit number written on them instead of four. In those instances, the first three numbers indicate the tensile strength. For example, E10018 would have a minimum of 100,000 psi. If you’re wondering how much tensile strength you need for a job, 60,000 is enough for building things like trailers.

The second last digit (Ex**1**x) corresponds with how fast the weld puddle solidifies and indicates the welding positions the electrode can be used in. This digit will either be a 1, 2 or 3. The 1 means the electrode can be used in all positions, the 2 means it can only be used in flat and horizontal fillet positions and 3 means that it can only be used in the flat position.

Welding positions are the position that the metal is in when we make our weld. You can weld in flat, horizontal, horizontal fillet, vertical and overhead positions. So far, we've only welded in the flat position, which is when we make a weld down onto a horizontal surface. This is the most commonly used welding position because the molten puddle is not affected by gravity as it is in other positions. This makes it easier to deposit a uniform bead with proper penetration at a fast speed. The horizontal fillet position refers to welding a joint, where one piece of the joint is in the flat position and the other is perpendicular (vertical) to that piece. In this position gravity can cause the molten puddle to sag slightly. The horizontal position is when the piece you're working on is held vertically, but you run the weld horizontally along this vertical surface. The vertical position is one where the material that we're welding on is vertical and the bead we run is laid vertically. And lastly, there is the overhead position, which is exactly as it sounds. It's when we make a weld above our head and so, because of gravity, is probably the most difficult of all the welding positions.

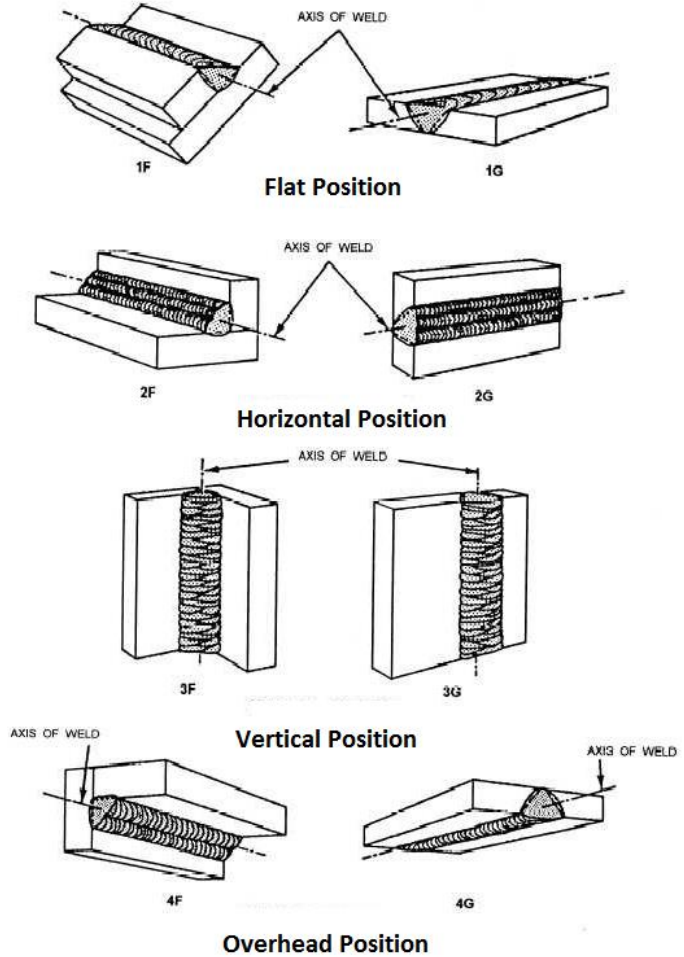

ACTIVITY

#40. Ways to Weld

The last digit, in combination with the second last digit (Exx**13**), indicates a variety of things including operating characteristics, composition of the flux coating and the polarity the electrode can be used with. There are too many combinations and characteristics to get into here. If you'd like to learn more

Key to Type of SMAW Coating and Current		
Digit	Type of Coating	Current
0	High Cellulose Sodium	DC+
1	High Cellulose Potassium	AC, DC±
2	High Titania Sodium	AC, DC-
3	High Titania Potassium	AC, DC±
4	Iron Power, Titania	AC, DC±
5	Low Hydrogen Sodium	DC+
6	Low Hydrogen Potassium	AC, DC+
7	High Iron Oxide, Iron Powder	AC, DC±
8	Low Hydrogen Potassium, Iron Powder	AC, DC±

about what the last two digits in combination mean, check out the links under resources at the end of this Unit. This chart has some information about what the last digit means, so use it as a reference whenever you need.



ACTIVITY

#41. Examining Electrodes



#42. Electrode Code

Welders use many different kinds of welding electrodes because there isn't a magical electrode that does everything. There are so many electrodes that it would be a challenge to try to become familiar with them all. If you're purchasing electrodes and not sure which ones to buy for the job you're working on you can obtain a list of all available AWS numbers from a supplier. This list will help you to select the right electrode for the project you're working on.

As a beginner you don't need to become familiar with every type of electrode. You just need to be acquainted with a handful that will work for most of your common welding needs. If you know a bit about the E6010, E6011, E6013, E7018 and E7024 you'll be all set for most of the welding jobs that you'll come across.

E6010 and E6011

These two rods have very similar characteristics. The difference between them is that E6010 can only be used on DC+ and E6011 can be used on AC and DC+. These rods are **fast-freeze**, have a strong arc force and provide deep penetration. They are a great choice when welding **out-of-position**. They are often used as a first pass or to fill gaps and then covered with a **filler electrode**. These rods also perform relatively well on dirty, greasy and rusty surfaces. So, if you are making repairs on farm machinery or joints that are difficult to clean properly, these electrodes are a good choice.

E6013

These are filler electrodes designed for welding in all positions with all polarities. However, they may be harder to use out of position. They make a great general-purpose electrode and are a popular choice for many welders because of how easy they are to use and how smooth the finished weld bead is. They can often be used for applications on the farm, although the metal has to be cleaned well (unlike 6010/6011). The deposited weld is high quality with low to medium penetration and was originally designed for use on sheet metal.

E7018

These are filler electrodes that produce high quality welds. They are generally used on DC+, but some AC 7018's are available. If quality and strength are what you're concerned about or you're working with hard-to-weld metals, then this electrode is a good choice. They can be used in all positions (although may be harder to use out-of-position) and produce a smooth finished weld bead. You must have a thoroughly clean work piece and well prepared joint to successfully weld with this electrode.

E7024

These are filler electrodes that can only be used for flat or horizontal welding and with AC or DC+. They were used extensively in fabrication before wire-feed welding (also known as MIG welding) because of how quickly they can deposit a great deal of weld material. These electrodes require a clean metal surface, operate at higher amperage and produce a weld similar in quality to E6013's. The finished weld bead is very smooth.

These are five very common electrodes and should be readily available. There are, of course, many more electrodes out there. Each with distinct characteristics and is designed for a specific purpose. No matter what your electrode choice is, making a weld is done in the same way: by using the techniques we learned in Unit 3 to run a weld bead. You may find that as a beginner mastering these techniques may be easier with a fast freeze rod because you can see the puddle better. Welds done with a fast-freeze electrode will do not look as "nice" as ones done with a filler electrode, but filler electrodes have thicker flux making it more difficult to see what the puddle is doing.

Having a nice weld is not nearly as important as making a weld that is done with proper technique producing a quality, strong weld.



ACTIVITY

#43. Testing the Difference

CHAPTER 4: Storing Electrodes

As the electrode burns, the gases from the flux protect the puddle so the gases in the air don't mix with the molten metal. If air were able to mix with the molten metal it would leave gas pockets in the weld bead which show up as tiny holes called porosity. These tiny holes decrease the strength of the weld. Beyond this, the flux helps stabilize the arc, which helps us to achieve maximum weld penetration and uniformity. It also lifts impurities from the molten metal. When the flux cools it creates a slag coating on the weld bead, providing even more protection from the air as it cools.

Basically what all this means, is that without flux the SMAW process wouldn't be possible. It's because of how important the flux is to the welding process that electrodes need to be stored and handled properly. Do not use electrodes with damaged flux. Beyond making your job difficult, damaged electrodes can form weak welds with defects. There are a few things we can do to insure that we don't damage the flux and keep the electrode in optimal working condition.

The first thing you can do is handle electrodes carefully. Don't be rough with them by throwing or dropping the electrode containers or carrying electrodes around in your pocket or tool box. Be careful that you do not bend electrodes in the stinger too closely to the coating because this could crack the coating further down the electrode. If you damage the coating of the electrode with a chip or a crack you can lose shielding, allowing contamination and porosity into the weld and lose arc stabilizers. This can make the arc difficult to maintain and control resulting in poor bead appearance.

The other thing you can do is to store electrodes in a dry, dirt-free area and avoid getting them wet/damp. Electrodes are very susceptible to moisture. Moisture causes the coating to disintegrate and fall off and a moist flux coating will result in low quality welds or an unstable arc.

As soon as you open a new package of electrodes, they start absorbing moisture from your shop. So they need to be stored in a sealed container. Taping up electrodes in the bag they came in is an adequate way to store them sealed. You also want to avoid getting electrodes wet by exposing them to rain, leaving them out in high humidity or dropping them in water/on a wet floor.

Hot Tip

The good news is that if you do get electrodes wet you can reclaim them by baking them in an oven. The temperature and time needed in the oven will vary from electrode to electrode and depend how wet they are. Usually baking them at 150-250°C for three hours will dry them properly so that they can be used again.

CHAPTER 5: Prepping for Welding Joints

Beginning welders often think that the heat generated by the electrode will burn away dirt, oil, rust, etc. But that's not so. As hot and powerful as the arc of an electrode gets, it doesn't clean away impurities. If the surfaces you are joining are not cleaned of contaminants before welding they can be included in the weld and cause defects and weakness. New metals that have **mill scale** on them also require joint prep before welding. Mill scale is a film left on some metals from the milling process and is bluish black in color.

There are a variety of methods you can use to clean the metal properly where it will be joined. Sandpaper or abrasive cloth are readily available and are a good option. Prepping a joint with these materials is often a better choice than using power sanders since it's very easy to remove more metal than you intend to with a power sander. Wire brushes or chemical cleaning agents are also a good option. Remember not to store these chemicals anywhere near where you'll be welding. For large scale jobs you may also want to consider sand blasting, followed by cleaning with an air compressor. If you can't get surfaces completely clean, 6010 and 6011 are suitable electrodes to use. But, even welds made with these electrodes will fail if the surfaces joined are too dirty.

Remember, if it is worth your time to weld something, it is worth your time to prepare the weld area before welding. By doing so, you ensure that the weld you make will be as strong as possible.



ACTIVITY

#44. How-To Video



#45. Question Toss

Unit 4 Resources

<http://www.lincolnelectric.com/en-us/support/process-and-theory/pages/understanding-polarity-detail.aspx>
<http://www.lincolnelectric.com/en-us/support/welding-solutions/pages/polarity-for-smaw.aspx>
http://www.mig-welding.co.uk/wiki/Electrode_Reference_Chart
<http://www.sweethaven.com/sweethaven/BldgConst/Welding/lessonmain.asp?lesNum=7&modNum=3>
<http://www.parselectrode.com/Welders%20hand%20book.pdf>
<http://www.metalwebnews.com/howto/weldrod.html>
<http://www.weldingtipsandtricks.com/shielded-metal-arc-welding-rods.html>
<http://www.mig-welding.co.uk/electrode-classification.htm>

Metal ID Websites

<http://www.weldingwire.com/applications/DocumentLibraryManager/upload/METAL%20ID.pdf>
http://igor.chudov.com/manuals/Spark_Testing_for_Mystery_Metals.pdf
http://www.esabna.com/EUWeb/oxy_handbook/589oxy24_4.htm (pages 4-6)
<http://www.sweethaven.com/sweethaven/BldgConst/Welding/lessonmain.asp?lesNum=1&modNum=4>
<http://everythingscrapmetal.blogspot.ca/p/metal-test-identification.html>

COMPLETE LIST OF UNIT 4 ACTIVITIES



#40. Ways to Weld



#41. Examining Electrodes



#42. Electrode Code



#43. Testing the Difference



#44. How-To Video



#45. Question Toss

Unit 5

Working with Welds



Bring with you to the meeting:

- Pen or pencil and notebook
- Clothes to weld in and safety gear (see appendix for the image of the well-dressed welder)

In this Unit we will:

- Learn about the different types of joints and weld anatomy.
- Find out how to weld butt joints, T-joints and lap joints in the flat position.
- Discover how to make large welds with weave beads and **multiple pass welds**.
- Talk about **distortion** and how to deal with it in our work.

CHAPTER 1: Joints

Now that we know how to pick the right electrode for the job and run good stringer beads by carefully watching the puddle, the world is ours to weld! The next step is to apply this knowledge into joining two pieces of metal together.

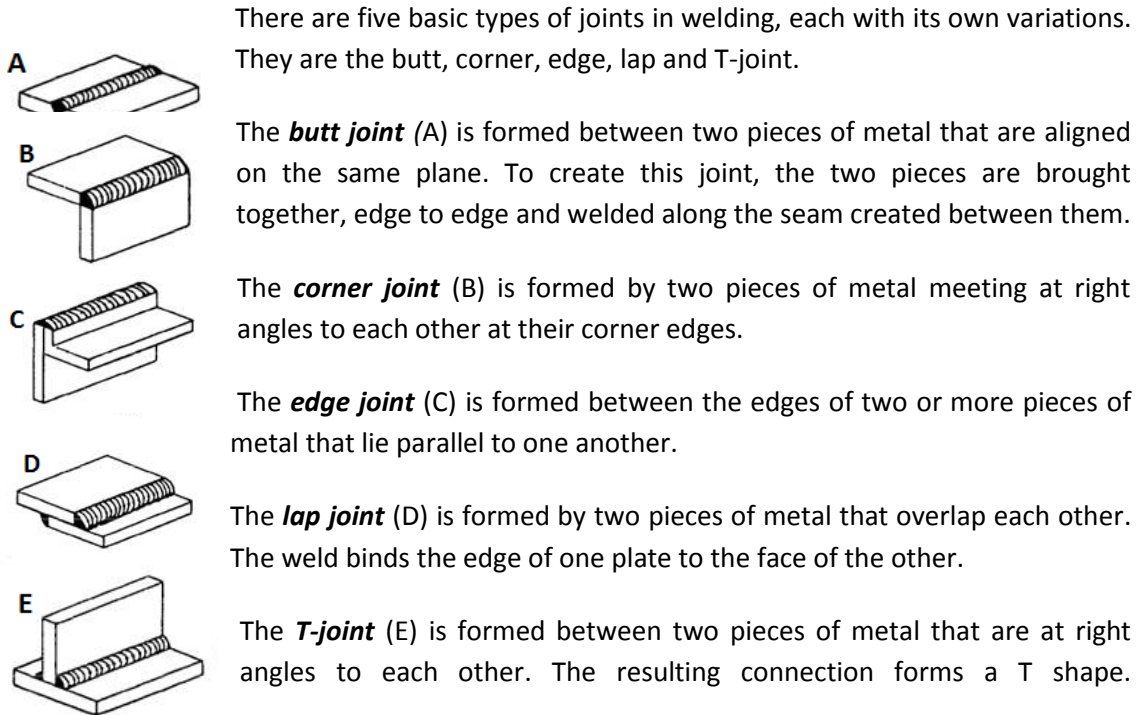

ACTIVITY



#46. Which Joint is Which



#47. Find the Joint

The two most common types of welds used in arc welding to make these joints are the **groove weld** and the **fillet weld**. Groove welds are used mainly for butt joints and can also be used in welding edge joints. Basically, with a groove weld, you leave a space between the two pieces of metal you're joining and fill it in with weld beads. Fillet welds are used commonly for welding lap, T and corner joints. To make a fillet weld a layer/layers of weld are deposited to fill in the corners created by the joints. The weld looks triangularly shaped. In this Unit we learn how to join butt joints with groove welds and lap joints and T-joints with a fillet weld. Once you know how to make these three different joints using these two welds, you can really get cracking on your individual and community projects.

No matter which joint you're welding, or type of weld you're using, you'll have to set up the joint before you begin. To do this you weld the pieces together with small temporary welds to hold the two parts in the correct position so that they don't move out of place when you do your actual welding. These small welds are called **tack welds**. They are not structural and should always be covered by another proper weld. When making a **weld pass**, you weld right through them. Position tack welds at each end of the parts you're welding. If a part is long or has an unusual shape you may need to use several tack welds along the length of the joint.

As you learn to weld these different joints you're going to come across a few new terms that describe the structure of a weld. Let's define them before we get going so that you aren't left scratching your head when they come up.

Root face, groove face and root edge – These terms all describe the surfaces along the groove, or along the edges that will touch, when the two pieces are welded together. The groove face is the surface of the metal that will be included in the weld. The root face is the surface of the metal that will be included in the weld that has *not* been prepared with a **bevel**. To make things even more confusing, in butt joints and T-joints, the groove surface and the root face can refer to the exact same edges! The root edge is a root face with zero width, meaning it's the tip of a triangle that will be included in the weld.

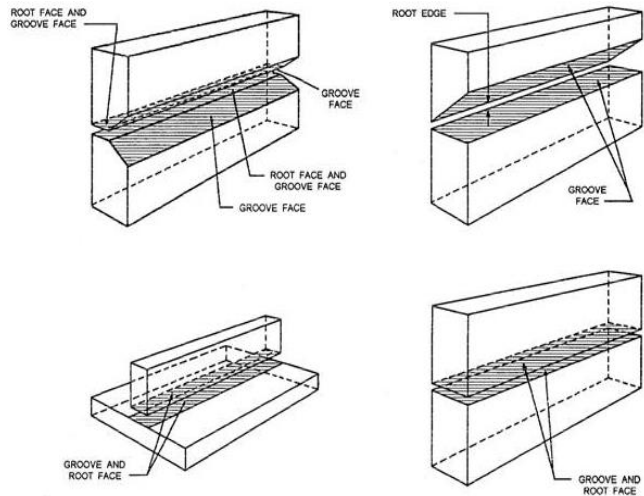

Root opening, bevel angle and groove angle – These words all refer to the space between the two pieces being joined together. The root opening is the space left (if any) between the two pieces at the root of the joint. The bevel angle describes the angle (other than square) put onto the edges that will be joined. The groove angle is the total angle of the groove between the two pieces being joined. For example, if two plates were both beveled to 30° angle, when they are put together the groove angle they create is 60°.

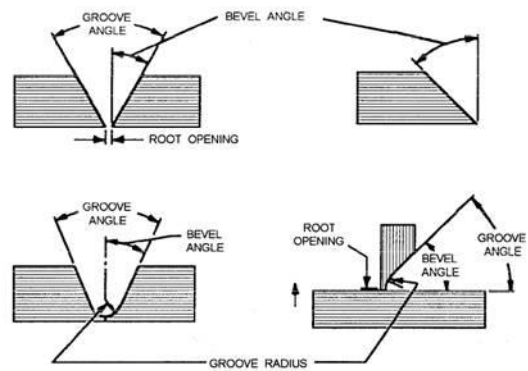

Weld root – This refers to the points where the bottom or back of the weld

Groove Welds

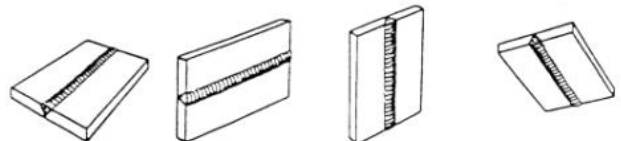

intersects with the base metal. In a fillet weld, the root is the point of deepest penetration.

Weld size – With a groove weld, the weld size is indicated by joint penetration. With a fillet weld, the size of weld is indicated by the leg length of the fillet.

Weld face – This is the exposed surface of a weld on the side from which the welding is done.

Weld toe – This is the junction where the face of the weld meets the base metal.

Leg of a fillet weld – This is the distance from the root of the joint to the toe of the fillet weld.

Fillet Welds

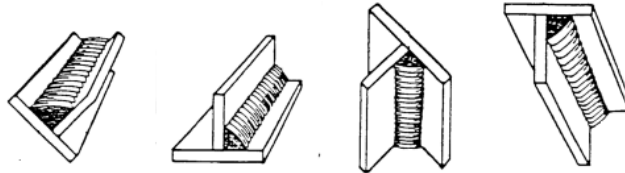

ACTIVITY

#48. What's in a Weld?

CHAPTER 2: Welding Different Joints

Butt Joints: How to weld a square butt joint in the flat position

The butt joint is made by welding the edges of two pieces together to make one flat piece. There are several different types of butt joints and different methods to weld each one. The type of joint and weld we use depends on the thickness of the metal, whether it will be welded from one or both sides, and how the edges are prepared. For now, we'll learn how to make a square butt joint in the flat position which is completed with a square groove weld. This weld is formed when we join two pieces with square edges together. Usually only materials that are 6 mm or thinner can be welded with a square groove weld.

If we were to butt two plates with square edges tightly together, and run a weld on either side of the joint, there would be an area in the centre of the joint that wouldn't be held together by the welds. To avoid this, we have to leave a space in between the plates we're welding. This way, the two beads can weld to each other in the centre of the plates, making the two plates become one solid piece.

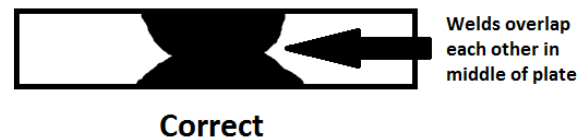
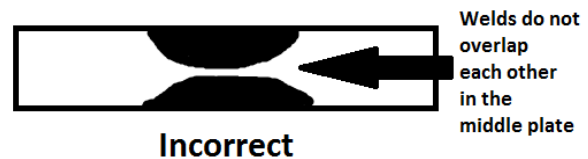

To weld a square butt joint, place the two plates flat (horizontally) on the welding table, leaving a small gap (root opening) between them. Leaving a gap about the size of the electrode core wire between the two plates is usually adequate. Tack weld the plates together at both ends to ensure that, as you weld, the root opening stays the same size. Without tack welding, the root opening can spread apart, or close up, as a result of the heat from the welding process.

Hold the electrode perpendicular to the plates and angled 10-30° in the direction of travel. Run a straight bead centered down the seam between the two plates.

If you're welding on material that is thin (3mm or less) you may only need to run a weld bead on one side of the joint. Normally, for full penetration, you need to turn the plate over and run a similar weld on the reverse side. Remember to make sure that these two welds are deep



Thin Plate
One weld bead is sufficient for 100% penetration

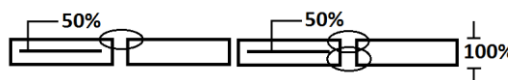

Thick Plate
Needs two beads for 100% penetration. First pass is made penetrating 50%. Plate is flipped over and second pass is made, penetrating at least 50%.

enough that they meet with each other near the centre of the plate.

When welding butt joints, the welds need to penetrate deeply enough so that the final weld deposit is at least as thick as the base metal. This is most easily done by running beads on both sides of the joint which provides maximum penetration and strength. However, usually only materials that are 6 mm or thinner can be welded with a square groove weld.

If you need to weld a butt joint between two thicker pieces of metal or on a joint that can only be reached to be welded from one side (on material that is thicker than 3mm) you'll have to prepare the edges with bevels first before welding. In Unit 6 you can learn the proper joint preparation and the corresponding welding technique for a butt joint with bevels like this.

Hot Tip

Bevels are angles cut into the edge pieces so that the root opening is larger. This makes it possible for electrodes to reach farther into the joint, which in turn will allow welders to get adequate weld penetration that would otherwise be impossible.



ACTIVITY

#49. Welding a Butt Joint

T-Joints: How to weld a T-Joint in the horizontal position

T-joints are made by welding two pieces of metal together to form a 90° angle. The weld is made on the inside corner created by the two pieces using a fillet weld. This is the most commonly used weld in welding fabrication and is often used when doing repair work on machinery. Most fillet welds are made in the horizontal position.

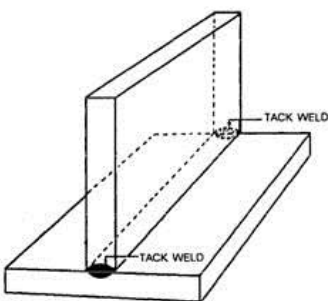

To make a T-joint in the horizontal fillet position one plate is placed flat (horizontally) onto the welding table. The second plate is placed perpendicular to the first plate so that it sits vertically with its edge resting against the first plate. This results in the two plates being at right angles to each other, forming an inverted T. The edge of the vertical plate should be tack-welded to the surface of the horizontal plate at both ends of the joint so that it will not move during welding.

When making T-joints, and any other fillet weld, you need to pay close attention to both electrode angles. Hold the electrode at a 45° work angle, so that it is pointed towards the middle of the joint, and at a 15° travel angle.

The work angle determines the position of the fillet in the joint (centered), and the travel angle determines the shape of the bead (how flat or rounded it will be). It's important when making fillet welds to hold the electrode in such a way that the legs of the bead are the same length along the top as they are on the bottom. You also need to make sure that the arc is directed into the corner of the joint, so that both plates are heated equally. To do this, it often helps if you hold the electrode so that its flux lightly touches both plates as you drag it along.

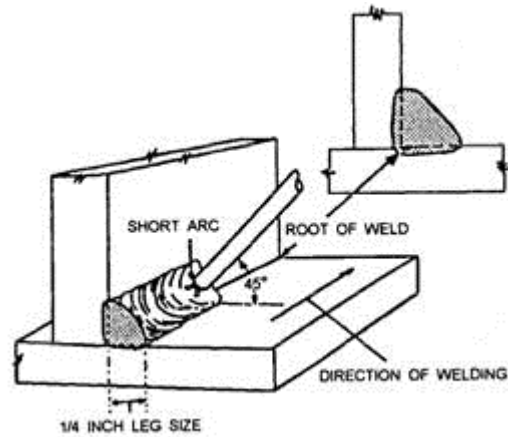

A short arc is also necessary when making a fillet weld to provide good fusion at the root and along the legs of the weld. Holding the electrode so that it touches both plates also helps to attain this short arc length. However, if you're welding two pieces together that are different thicknesses, you need to direct the arc more towards the thicker piece so both plates of metal are heated equally.

Move the electrode ahead to create a fillet weld in this manner, joining the plates together. Carefully observe the puddle as you weld, changing the angle or speed if it sags or if there is undercut (which tends to happen on the vertical plate). The finished weld should penetrate equally into each plate. As a beginner, a common problem when welding T-joints is to burn through the vertical piece, and get insufficient penetration along the horizontal piece. If you hold the electrode at the correct angle you should be able to avoid this problem.

You may also notice that when finished, the T-joint warps in towards the direction of the weld, which ends up leaving the joint you've made narrower than the original 90° you set out to make. This happens because metal shrinks as it cools. To prevent this from happening, tack weld the vertical plate so that it leans back slightly. Then, once welded, as the joint cools/shrinks the vertical plate will end up being pulled perpendicular to the bottom plate, just like you want! Or, weld on both sides of the joint, alternating welding passes between one side of the joint and the other. When you weld on both sides of the joint like this it is called a **double fillet**. If you only weld on one side of the joint it is a **single fillet**. Whenever possible, weld on both sides of the joint because double fillet welds make a stronger joint.

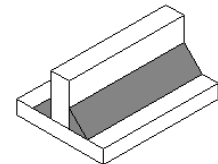

No matter which type of joint you're welding with a fillet weld, you need to make sure that you're using enough heat for the arc to penetrate right down into the corner of the joint so that you end up with a strong joint. With any fillet weld, the finished bead should not only be uniform and smooth, but also be flat or slightly **convex** (rounded) because **concave** beads are prone to cracking. You should also try to ensure that the leg of the weld is equal to the thickness of the parts being welded. If you are unable to get the legs of the weld to be equal in thickness to the material you're welding try using a larger electrode to make a wider weld. If you're still unable to achieve the correct sized weld, you'll have to make a bigger weld bead by making more than one pass, which we'll learn to do in the next chapter.



ACTIVITY

#50. Welding a T-Joint

Lap Joints: How to weld a Lap Joint in the horizontal and flat position

Lap joints are formed by two plates overlapping each other. When you weld a lap joint, you are joining the surface of one plate with the edge of the other plate by running a fillet weld along the inside corner of the joint created by the overlap. Because T-joints and lap joints are both welded with fillet welds, the technique for welding them is very similar. This biggest difference is that with a lap joint, you have to be careful to avoid overheating the outside edge of the overlapping plate.

To weld a lap joint in the horizontal fillet position lay one piece flat (horizontally) on the welding table and then lay the second piece (horizontally) on it so that the two pieces overlap.

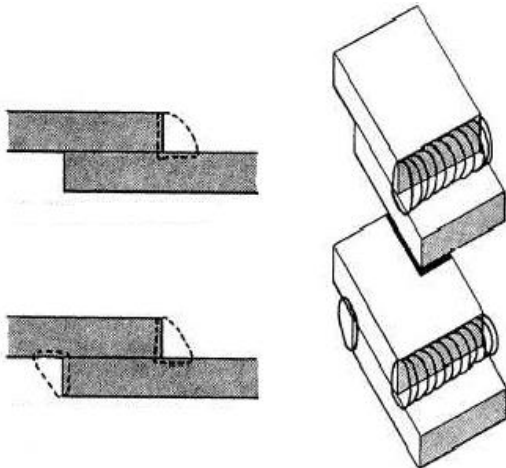

When this is done, two corners (joints) are formed, one on the top side of the plates, and the other on the bottom side of the plates. Lap joints can be welded on one or both sides. Whenever possible, you should weld on both sides of the plates because it will be stronger. When you weld both joints created by the two overlapping plates like this it is called a double fillet weld.

You should fit up the joint so that there is no gap between the two plates and then tack-weld them in place, so that they will not move during welding. To reduce the risk of warping, you should tack each of the four corners (the corners on the top joint and on the bottom joint). Remember when making tack welds to

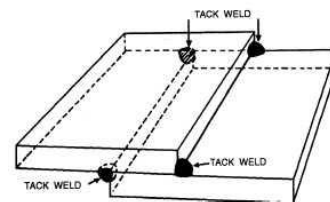

make the welds small enough so that when you run your actual fillet weld, you can weld through them, incorporating them into the weld bead.

Just like making a fillet weld with a T-joint, the electrode should be held at angles that allow the arc to heat both plates equally and form slightly convex beads when making a lap joint. To do this, hold the electrode at about a 45° work angle and tilted with a 15° travel angle. If you are welding plates of different thicknesses direct the arc more towards the thicker plate so that both plates heat evenly.

Move the electrode ahead like this in a straight line along the joint. Watch the bead as it builds up, changing your angle or speed if it sags or undercuts, which is a common problem along the horizontal piece. The edge and the top corner of the overlapping piece are going to get hot and melt faster than the surface of the other piece. So as you weld, watch the top edge of the joint. As soon as the side of your puddle meets the top edge, move on to your next puddle.

The goal when making a lap joint is to get good penetration right down into the corner of the joint. The legs of the weld should come up and out at a distance that is equal to the metal being welded with little or no undercutting. On thicker metal, you might not be able to make fillet welds that are large enough in one pass. If this is the case, the next chapter will guide you through a multi-pass welding procedure. Your finished fillet weld should be uniform, smooth, slightly rounded and penetrate evenly into each plate.

If you want to make fillet welds on lap joints or T-joints in a flat position, instead of in the horizontal fillet position, it is possible. You simply need to tilt the work so that the corners of the joint become a trough for the molten puddle. Welding like this can often be faster, but sometimes, depending on what you are working on, rigging the piece that you're working on to sit at this titled angle can be difficult and sometimes impossible.



ACTIVITY

#51. Welding a Lap Joint



#52. Skill Plate

CHAPTER 3: Making Wider and Bigger Welds

Making Weave Beads

So far, all of the weld beads we've made have been stringer beads made with little or no *oscillation*. But, there are actually several other beads called *weave beads*, which we can run. Just as the name suggests, we run these beads by adding a weaving motion into our electrode movement. Weaving is a small back and forth motion crosswise to the direction of travel.

The point of learning how to run a weave bead isn't to make things more complicated. The goal in welding is that the completed weld to be just as strong, or stronger, than the base metal. When we start joining thicker pieces of metal together, a single stringer bead like the ones we've been making, is not able to make a weld that is large enough or strong enough to correctly join the pieces together. In these instances, weaving is a very useful technique to use to make wider weld beads that will be strong enough to hold the joint together. Weaving can also help prevent the bead from running and dropping when you need to weld out of position. Welding with weave beads will often cause less distortion than stringer beads.

There are several different ways you can run a weave bead. "A" is a weave made with a simple zigzag motion. "B" is probably the most commonly used weave. It is also made with a zigzag motion, except that each zig and zag is made crescent shaped instead of straight. "C" is done with a figure-8 motion and "D" is done with a small circular motion. It's important to keep the circles small and tight to end up with a smooth weld bead. "E" makes a hesitation at each side of the weave to allow a slight buildup of metal at the edges of the joint.

Spark of Information

Out of position welding =
welding in any other
position other than flat.

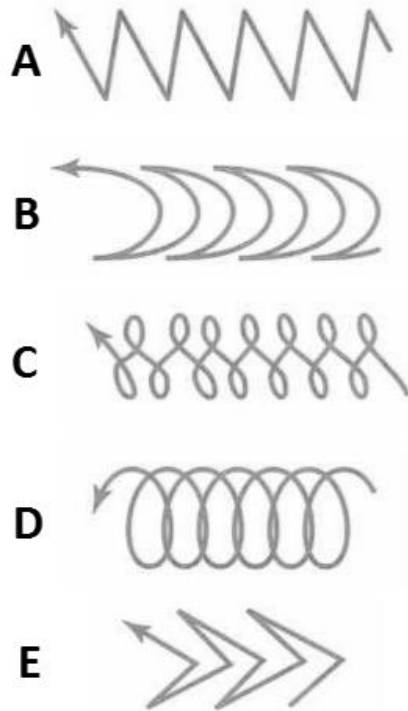

You use the same techniques to run a weave bead as you would a stringer bead, watching the puddle and paying attention to arc length, travel speed and electrode angle. The only difference is that when running a weave you also need to pay attention to moving the electrode from side to side as you move it forward. If you move the rod too far to one side or another you give the molten metal at the opposite side time to harden and for slag to form over it. If this happens,

when you bring the rod back to that side the slag will get trapped in the weld making it weak. To avoid this, the weave should not be made wider than three times the diameter of the electrode.

Forming a uniform bead with a weave can be tricky for beginners. But, if you watch the outside edge of the puddle to make sure it is as wide as the weave before it and watch the top the puddle as you pass the centre to see that it builds up as high as the pass before it you should end up with a fairly consistent and uniform bead. It is also a good idea to make a slight pause at the end of each weave allowing the weld to build up. This ensures good fusion and prevents undercutting. If done properly, a weaving motion can float out slag, secure good penetration at the edges of the weld and avoid porosity by allowing gases to escape. Weave beads, however, usually do not penetrate as deeply into the base metal as stringer beads.

If you ever get the opportunity to visit a welding shop, watch welders at work and see what techniques they use to run beads. You'll probably notice that each welder has his/her own personal style and preferences. Some welders change the type of bead they use when they work on different types of joints and in different welding positions. And some welders use the same bead for all of their welds with slight variations in speed and size.



ACTIVITY

#51. Welding With Weaves



#52. Pad Practice With Weaves

Making Multiple Passes with Fillet Welds

When we join thick pieces of metal together sometimes a weave bead by itself still won't make a bead wide enough to properly join the metal we're working on. When this is the case, we need to make multiple passes using stringer beads and/or weave beads. The first pass in a multi-pass bead is called the **root pass**. Succeeding passes are called **fill passes**.

The choice of which bead to use and how many passes to make depends on the thickness of the metal being joined. Anywhere from two to 20 or more passes may be used to make a bead large enough for the parts being welded together. But, it is best to try to make the weld in as few passes as possible. Since the goal is to make a weld that is as thick as the base metal, there is no point in running more beads once this is achieved. It is important when making multiple passes that each bead be placed in the proper sequence and relationship to the other beads.

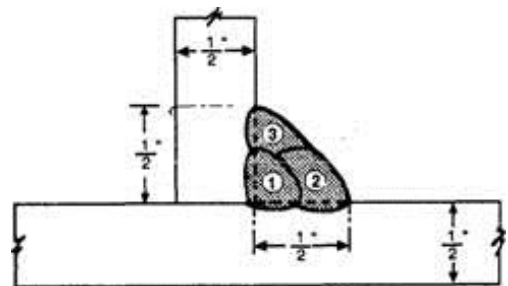

Hot Tip

The size of the finished fillet weld should correspond with the size of the metal it's joined together, with the leg lengths of the weld being equal in thickness to that of the metal plate.

It's likely that the fillet welds you'll be making when working on your projects will not require more than three passes. Normally, when making fillet welds, only plates that are 9mm or thicker will require multiple passes. A proper three-pass bead on a fillet weld should be done in this order:

To make a three-pass weld like this, the first pass is laid right in to the corner of the joint, just as if you were making a fillet weld that only needed a single pass. Then, the second pass is laid to cover the seam between the first weld and the bottom base metal. It should cover about 50-75% of the first weld.

The electrode will need to be at about a 60° angle from the horizontal plate to do this. Lastly, the third pass is made, covering the seam between the second weld and the first weld, as well as the seam between the first weld and the vertical plate. It should cover the second weld by 50-75%. The electrode will need to be at about a 30° angle from the horizontal plate to do this. Remember to chip off the slag from each bead before running the next one.

If you do have to make a weld that requires more than three passes, they are all completed in the same way; with each new pass partially covering the preceding pass.

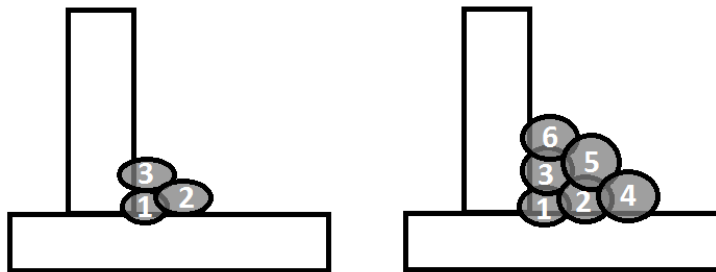

Making multiple passes on butt joints usually requires special edge preparation, so it will be covered in the next unit.



ACTIVITY

#55. Making Multiple Passes

CHAPTER 4: Distortion



Flat work pulled out of line



Vertical work pulled off center



Flat work is drawn into curve

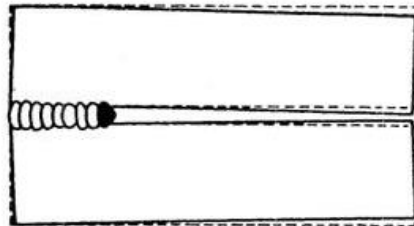

Spacing closes

In order to set up joints and make a weld there is one more thing we need to know about. Distortion! Distortion is the name used to describe plates that bend or twist out of shape after they've been welded. If when you were welding T-joints, the vertical piece leaned in towards the welded side of the joint instead of standing straight up, you've already encountered distortion! In order to combat distortion in our work we need to know what causes it and then take extra measures to minimize its effects.

When we weld, quite a lot of heat is built up in the weld and in the parts near the weld. Whenever metal is heated it expands. And then as it cools, it contracts. It's these expansion and contraction forces that cause distortion in welding. As the deposited weld cools, it shrinks, pulling with it whatever metal it is attached to. And as the metal close to the weld shrinks, its movement is restricted by the weld, causing it to bend or twist. There is

absolutely nothing we can do when welding to stop this expansion and contraction since it will always happen when metal is heated.

We can, however, figure out how these forces will affect our work and prepare for them. By planning our welds in advance we can reduce the amount of heat we use, anticipate how our pieces may move and work to balance out the distortion forces. Taking the time to prevent distortion by planning our **welding sequence** in advance is time well spent. Doing so is much easier than dealing with a finished weld that is fused together at incorrect angles or warped and twisted.

Here is a list of things you can do to help prevent distortion:

1. **Do not over-weld.**

In welding, more doesn't mean better. Excessive amounts of weld metal results in excessive heat. More heat equals more expansion and contraction which can lead to more distortion. You should stop



CORRECT

welding when you have deposited enough metal to create a joint as thick as the base metal. Making a weld that is larger than required is also a waste of time and money.

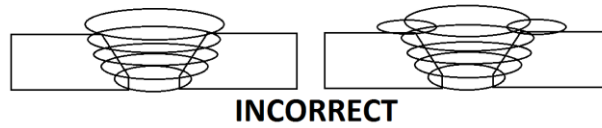

2. Prepare joints with correct spacing.

Leaving too much space between joints means making welds that are bigger. Bigger joints require more weld material and more heat than smaller, well-spaced joints. Be sure to tack-weld joints so the correct spacing is maintained as you weld. When putting bevels on edges to be joined, avoid making a bevel with a low angle, as this results in a joint that is larger than necessary. The joint should also fit together easily without being forced.

3. Use as few passes as possible.

You should limit the number of weld passes to the amount necessary to properly complete the job by using larger electrodes. Larger electrodes deposit a larger weld bead, which means less passes are made, less heat is built up and welds take less time to complete.

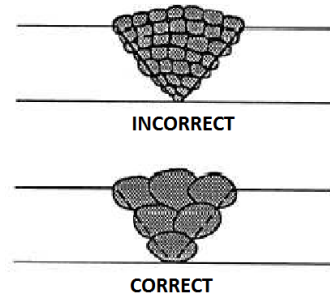

4. Use back-stepping.

When a continuous bead is laid, joints can spread open as they are welded. Back-stepping helps prevent this spreading. To back-step, a short weld is made at one end of the plate. Then, a space is left between this first weld and the start of the second weld. The second weld is then deposited towards the first weld until the two are connected. A space is left between the second weld and the third, and the third is deposited towards the second, connecting with it, and so on.

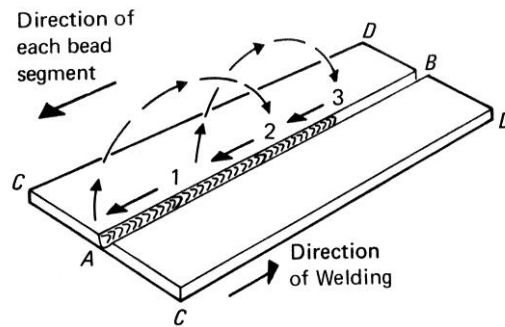

5. Use intermittent welds (skip welding).

Making intermittent welds, instead of one continuous bead, helps disrupt the shrinkage forces by avoiding concentrating them all on one area at one time. To intermittent weld, a short weld is made at the beginning of the joint. Then, a section is skipped, and further down the seam another short weld is made. This is continued along the length of the seam. Once you reach the end, you can come back and weld in the skipped spots. Using

this welding method to weld square or round tubing is an especially good idea: weld top, then bottom, then side, then other side.

6. **Weld on both sides of the joint.**

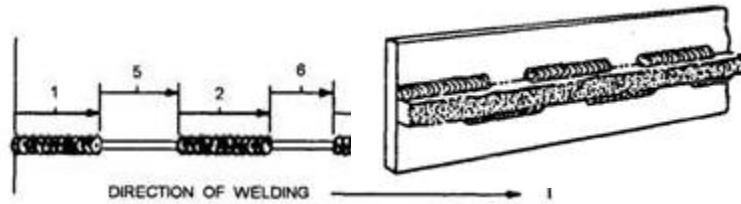

Welding on both sides of the joint counterbalances the distortion forces. Whenever possible, weld on both sides of the joint and use intermittent welding, alternating passes between one side of joint and the other.

7. **Use a weave.**

A weaving pass usually has less penetration than a straight pass, but will usually causes less distortion.

8. **Position plates out of alignment.**

You can use the shrinkage force of metal to your advantage by positioning plates out of alignment by tacking them or bending them out of alignment. To do this, position the pieces so that they are angled slightly in the opposite direction from where the contraction will take place. You then rely on the weld to pull the pieces into their proper positions as it cools. It does take some experience to figure out where to properly tack pieces so that they end up in the position that you want.

9. **Use clamps and jigs.**

To prevent excessive movement you can use jigs and clamps to hold the parts you're welding in a fixed position. This will help counteract some of the distortion forces.

10. **Peen the weld.**

This is just a fancy way of saying "hit the weld with a hammer." Stretching the weld with hammer blows relieves some of the internal stresses that can cause distortion.

ACTIVITY



#56. Working with Contraction Forces



#57. Defeating Distortion



#58. How-To Video

Unit 5 Resources

- http://www.millerwelds.com/pdf/guidelines_smaw.pdf
- <http://www.sweethaven.com/sweethaven/BldgConst/Welding/lessonmain.asp?lesNum=3&modNum=2>
- <http://www.sweethaven.com/sweethaven/BldgConst/Welding/lessonmain.asp?lesNum=3&modNum=5>
- <http://www.mig-welding.co.uk/arc-fillet-joints.htm>
- http://deltaschooloftrades.com/basic_joints.htm

COMPLETE LIST OF UNIT 5 ACTIVITIES



#46. Which Joint is Which



#47. Find the Joint



#48. What's in a Weld?



#49. Welding a Butt Joint



#50. Welding a T-Joint



#51. Welding a Lap Joint



#52. Skill Plate



#53. Welding with Weaves



#54. Pad Practice with Weaves



#55. Making Multiple Passes



#56. Working with Contraction Forces



#57. Defeating Distortion



#58. How-To Video

Unit 6

Master New Skills



This Unit is designed as an “instructional dictionary.” In order to use it you don’t need to go through the whole unit all at once. In fact, since you’re probably itching to spend more time working on your individual and community projects, you should only read this unit if, and when, you need to learn how to weld out of position, weld on sheet metal or use a joint that wasn’t covered in Unit 5.

When you encounter things that we haven’t already covered while working on your projects, you can stop, come here and look up how to properly make the weld. Then do an activity to practice the skill and once you feel that you’re able to make a quality weld using your new skill, go back to your project to complete the weld. Don’t worry or feel nervous when you have to learn a new welding skill in order to complete your project. Because you already know how to make the three most common joints in the flat position, you will definitely be able to learn how to make any other weld in any other position.

Hot Tip

Keep in mind, welding in the flat position is always the easiest and usually the fastest way to weld. So, whenever possible, try to position your work so that it is in the flat position even if you know how to weld out of position.

Instructional Dictionary Index

Multi-Pass Butt Joints	85
V-Groove Butt Joint (Flat Position)	86
Corner Joints	88
Edge Joints	89
Sheet Metal (Thin-Gauge Metal) welding	90
Out of Position Welding	91
Whipping Motion	91
Forehand Welding	92
Horizontal Welding	93
Horizontal Stringer Bead	93
Horizontal Square Butt Joint	93
Horizontal V-Groove Butt Joint	94
Vertical Welding	95
Vertical-Down Welding	95
Vertical-Down Fillet Joint	95
Vertical-Down Square Butt Joint	96
Vertical-Up Welding	97
Vertical-Up Fillet Joint	97
Vertical-Up V-Groove Butt Joint	98
Overhead Welding	98
Overhead Fillet Joint	99
Overhead Square Butt Joint	100
Overhead V-Groove Butt Joint	100

Multi-Pass Butt Joints

A pass made by an electrode can only penetrate the base metal so deeply. This means that when we make a butt joint with material that is thicker than 5mm we need to specially prepare the edges of the plates we're joining. By doing so, we create a larger groove in the joint. This allows the electrode to get into the joint far enough to deposit multiple passes of weld metal that will penetrate through the entire thickness of the plate.

There are a variety of angles and shapes called **profiles** that we can cut into edges to create these grooves. The profile you choose to use will depend on the thickness of the metal being welded and if the joint can be reached from one side or both. The most common profile used in welding is the bevel to form a single V- or double V-groove.

V-grooves will allow you to get proper penetration in plates that are 5-19mm thick. If you're butt joining metal thicker than that, the U-groove is a good option. Thankfully, the technique for welding grooves made of these various profiles is very similar. So, once you learn how to weld one, you should be able to weld them all.

The thickness of the material you're welding is what determines the bevel angle, groove angle and root opening of the joint. You want to make a groove that is large enough for the electrode to fit inside so that you can pass a bead at the root of the joint, ensuring adequate penetration. You also want to avoid making bevels that are too large. Bevels that are too large result in an excessively large groove and add no strength to the finished weld. They also add unnecessary heat into the weld and take more time to complete.

Normally when making V-groove butt joints, a bevel angle on each edge of 30° is suitable. Together, the two bevels would make a groove angle of 60°. There are a number of different methods that can be used to put profiles on the edges of plate, such as using a grinder,

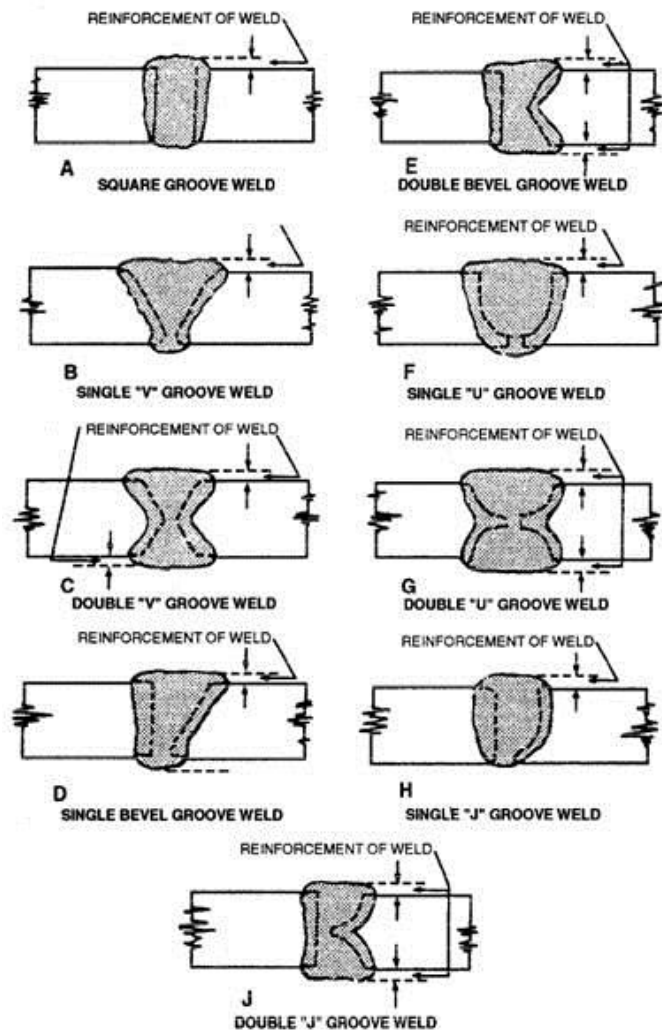

acetylene torch, plasma cutter, etc. Since the method you'll use will depend on what is available in your shop, we won't cover the different methods in detail. If you do need to put a profile on plates have your leader help you.

V-Groove Butt Joint (Flat Position)

There are a number of different ways you can set up a V-groove butt joint. You can make a single V-groove or a double V-groove.

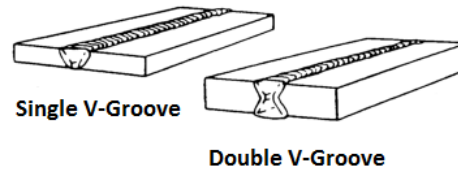

You can choose whether you use a **back-up bar**, also called a **back-up strip**, (single V only), whether or not you leave a root face on the bevel and if you leave a root opening or not.

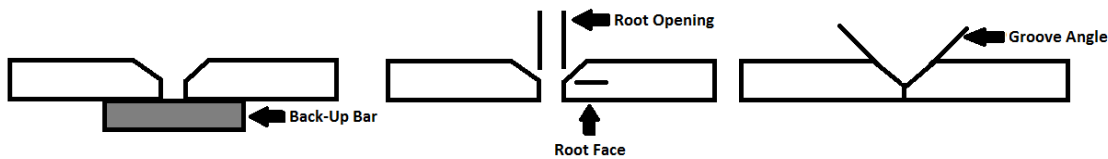

The great thing about these choices is that you can design the best V-groove for the joint you're working on. No matter what, you need to choose an option that allows you to get 100% penetration.

Some things that will influence this choice are the strength requirements of the joint and the thickness of material being joined. Material that is 5-19mm thick is appropriate to weld with either a single V- or double V-groove. Material that is 3-5mm thick that can only be welded from one side should be welded with a single V-groove. And material that is thicker than 19mm should be welded with a double V-groove.

Spark of Information

Your personal preference will also play a part of this choice. You may find that one method is easier for you. As long as the method you prefer to use meets strength requirements, it is fine to use.

Besides thickness of material, when trying to figure out which set-up is best for the joint you're working on ask yourself questions like these:

- Does the joint require maximum strength? If yes, a double V-joint is the best option.
- Can the joint only be made from one side? If yes, it has to be done with a single V.
- Do I have a tendency to burn through the fine edges of the bevels? If so, preparing bevels with root faces or using a back-up bar will be a better option.

- Am I able to get penetration through to the other side of the joint on my first pass? If not, a larger root gap could be used.
- Would it be appropriate to place a back-up bar behind my single V-groove? Doing so can help you have better penetration.

These are just some of the examples of questions you need to ask yourself. Regardless of what combinations you choose to make the groove weld, the bevels should be about 30° on each plate, resulting in a 60° groove angle.

V-groove weld instructions:

1. Fit-up the joint so that it is wide enough for your electrode to fit into. Be sure to maintain a root gap that is appropriate for the thickness of metal being welded. Tack-weld plates together to form desired joint with even root gap all the way along.
2. Hold the electrode pointing directly into the root of the weld and tilted 20-30° towards the direction of travel.
3. Strike the arc and lay a root pass at the bottom of the V. If you burn a hole through the narrow beveled edges, stop and restart the bead ahead of the hole and continue the weld. Come back when finished to fill the hole.
4. Chip off the slag and check to see that you have attained complete penetration and even fusion into each plate. The root pass must penetrate through to the other side of the joint, creating a crown on the underside.

5. Run successive passes to fill the V as shown in the image, laying each bead so that it completely covers the last. You may use a weaving motion to create fill passes that are wide enough. When the V becomes larger than three times the electrode diameter, lay stringer beads side by side to build up the weld. These side-by-side beads are laid in the same way as the beads you made when building a pad; with each bead overlaps the one before it in such a manner that a smooth surface is created, with no dip between the two beads. Remember to clean each bead before running another pass.

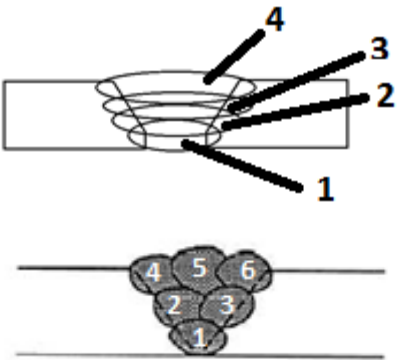

6. If welding a double V-groove you should alternate passes on either side of the weld as you build it up.
7. Continue passing beads until the weld is flush with the surface of the plates. The number of passes required to finish a butt joint depends on the thickness of metal. To

reduce the number of fill passes used, switch to a larger electrode as the weld progresses and increase the amperage accordingly.

8. Lastly you need to cap the weld off. The cap welds both edges of the plates in with the last layer of fill passes. The cap only needs to be slightly wider than the bevel and just above the surface of the base metal. Depending on the size of the weld it can be done with a weave bead or with multiple stringer beads creating a smooth, even surface.



ACTIVITY

#59. Mastering a New Skill



#60. How-To Video

Corner Joints

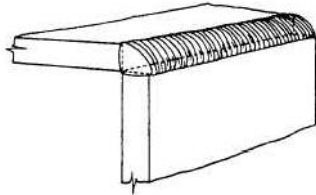

Corner joints and their corresponding welds are used on a number of jobs. They can be used on material of any thickness and no edge preparation is needed because square edged plates can be tacked together to form a V at the corner.

A full open joint (image 1) can be used for maximum strength. A half open joint (image 2) may be used where less strength is needed. A closed joint (image 3) can be used when tightness is the only thing needed.

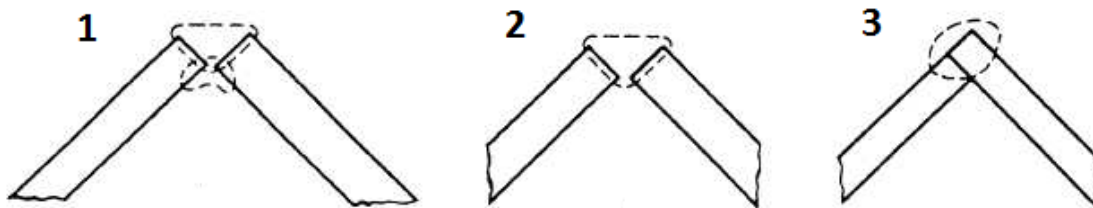

Corner welds on thin metal tend to spread apart easily so need to be tack-welded at closer intervals. Back-step welding will minimize distortion.

The procedure for making corner joints is similar to V-butt joints. For maximum strength a fillet weld is necessary on the inside.

Corner joint instructions:

1. Tack-weld plates together to form desired corner. For maximum penetration you could leave a small root gap.

2. Hold the electrode pointing directly into the root of the weld and tilted 15-20° towards the direction of travel.
3. Strike the arc. Maintaining a short arc length, lay the bead using a slight weaving motion.
4. If multiple passes are needed, clean the first pass well and lay a second bead over it using a weaving motion. Be sure your weave is wide enough to cover the first pass and penetrates evenly into each plate.

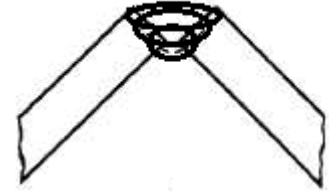

ACTIVITY



#59. Mastering a New Skill



#60. How-To Video



#61. Larger Than Life Dice

Edge Joints

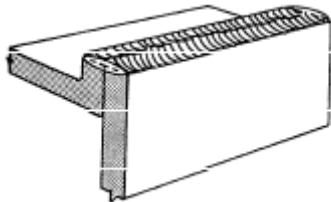

Sometimes called **flange welds**, edge welds are usually only done on joints that are not subject to heavy loads. They are also usually only done on material that is thinner than 6mm. The procedure for making edge welds is similar to running a bead on a flat plate, except that you have to be sure to keep the bead evenly on the narrow edge.

Whenever possible these welds should be made in the flat position. When it is necessary to weld edge joints vertically, the down welding technique should be used.

Edge joint instructions:

1. Tack-weld plates together leaving no root spacing.
2. Hold the electrode perpendicular to the joint (90°) and tilted 15-20° towards the direction of travel.
3. Strike the arc. Maintaining a short arc length, move along quite quickly, completing the weld in one pass. If material is too thick for the bead to



penetrate the joint you must prepare the joint with bevels and weld them similarly to V-groove butt joints.

4. The finished weld should be fused evenly into each place and be a uniform height the entire way along.



ACTIVITY

#59. Mastering a New Skill



#60. How-To Video

Sheet Metal (thin-gauge metal) Welding

The use of sheet metal around the shop is very common. Technically, sheet metal, also called thin-gauge metal, is less than 3mm thick. Most sheet metal is mild steel with a coating of zinc or iron. Tractor and car bodies are made of sheet metal. They are usually mild steel covered by primer and paint.

The good news is that if you're wanting to work with sheet metal you use the same techniques as if you were welding a thicker plate. However, there are some problems specific to sheet welding that you should know and take into consideration before beginning a job with sheet metal. Because of how thin sheet metal is, using the correct amount of heat is very important. Too little heat will not maintain the arc and too much heat will quickly burn through the base metal. Distortion due to expansion and contraction is also much more problematic when welding lighter material.

There are several things you can do to make welding with sheet metal go smoothly.

- Joints should have good fit-up and be carefully tack-welded.
- Use electrodes that are designed for welding sheet metal. These electrodes produce a softer arc. Definitely avoid using electrodes with deep penetrating characteristics.
- Tip the base metal up 10-25° and weld downwards. This will help you weld faster and have less penetration; both of which are desirable when working with sheet metal.

Hot Tip

When learning, it's likely that your first attempts at welding sheet metal won't be successful because of burn-through problems. But don't get discouraged. Keep trying, adjusting the current and varying your travel speed.



- If a gap exists in the joint, use a back-up bar to protect from burn-through. If you don't wish for the back-up bar to be part of your final weld use a copper strip because weld metal will not stick to copper. Back-up bars also help to prevent distortion.



ACTIVITY

#59. Mastering a New Skill



#60. How-To Video

Out of Position Welding

The easiest way to make a quality weld is to have the work lying flat. In the flat position, the work is less tiring, welding speed is faster, the molten puddle is less likely to run and better penetration can be achieved. However, when welding in the flat position is not possible you need not worry, we can make any weld we need to horizontally, vertically or overhead.

When welding out of position, electrode movement and arc length become even more important. Because gravity will cause the molten puddle to sag it's necessary to keep the puddle smaller than when welding in the flat position. This is done by using less amperage and using the force of the arc to help keep the puddle in place. You should also use an electrode that has fast-freeze characteristics when welding out of position.

Hot Tip

Practice welding in these new positions before attempting to do them on your own projects.

Whipping Motion

A whipping motion is another technique that can be used to run a weld bead. It is especially useful when welding out of position or when burn-through is a problem. It is accomplished by flicking the wrist to whip the electrode while holding the arm steady. With the flicking motion, the electrode is whipped quickly away from the crater and moved ahead to lengthen the arc, allowing the metal to solidify. The electrode is then immediately returned to the crater to continue the weld. Every time the electrode is whipped away, the puddle is given time to solidify. Because of this, whipping is used when welding out of position to prevent the puddle from running and sagging. It is a good idea to practice whipping on a flat surface, before trying to master it out of position.

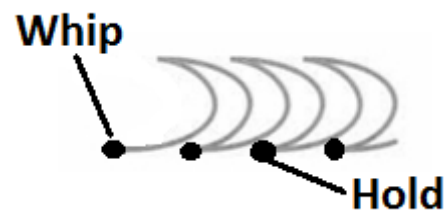



ACTIVITY

#59. Mastering a New Skill



#60. How-To Video

Forehand Welding

All this while, we have been doing what is called **backhand welding**: pointing the electrode back towards the weld puddle as we move it forward. There is another way to weld called **forehand welding**. With forehand welding the electrode is pointed in the direction that we are welding, with the tip pointed away from the weld bead we're making.

Backhand welding is used for most welding operations and forehand welding is used almost only when making vertical-up passes. Although it is rarely used for anything other than vertical-up, you can use forehand welding in other positions to make a deeper penetrating weld. Because it's always easiest to master a technique in the flat position it is worth trying your hand at forehand in the flat position before trying it to make a vertical-up weld.

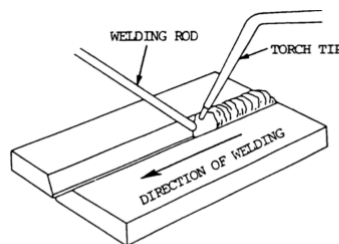

Forehand Welding

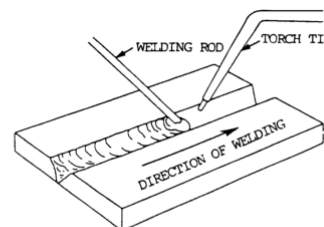

Backhand Welding



ACTIVITY

#59. Mastering a New Skill



#60. How-To Video

Horizontal Welding

We've already learned how to make horizontal fillet welds (in Unit 5 when you made your lap and T-joints). There are other joints that may also need to be welded horizontally. These are welds on a plate that is in the vertical position, but where the joint runs along the plate horizontally, parallel to the ground. All the joints you might encounter in horizontal

Spark of Information

A challenge when making horizontal welds is that gravity can cause the molten weld metal to sag before a uniform bead with sufficient penetration can be deposited.

welding are done similarly to either running a horizontal bead on its own or making a butt joint.

Horizontal bead instructions (same techniques are used to weld a horizontal edge joint):

1. Tack-weld a plate to a piece of scrap metal so that it is positioned vertically or use clamps to hold it in position.
2. Hold the electrode at about 5° below perpendicular to the plate and tilted 70-75° in the direction of travel (which makes it a travel angle of 15-20°).
3. Strike the arc on the vertical plate and draw the bead along holding a short arc.
4. Make sure you are depositing molten metal along the vertical plate. If the molten metal is sagging or running down the plate try lowering the amperage and/or using a whipping motion.

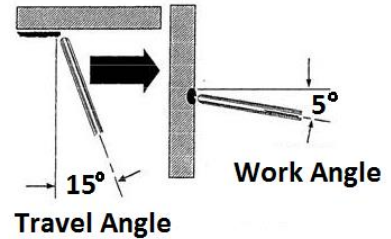

ACTIVITY



#59. Mastering a New Skill



#60. How-To Video

Horizontal square butt joint instructions:

1. Tack-weld two plates together (that are appropriate thickness to be welded with a square butt joint) to form desired square butt joint, leaving proper root gap.
2. Secure plates in vertical position.
3. Hold the electrode just below perpendicular to the plate (about a 5° angle) and tilted 15-20° towards the direction of travel.
4. Strike the arc and run the bead along the joint using a slight whipping motion.
5. Maintain a short arc while welding and if the puddle is difficult to control or sagging, reduce amperage. Ensure that weld is penetrating at least halfway through the joint and that the bead is fusing evenly to each plate.
6. Weld the reverse side of plates in the same manner, ensuring beads meet in middle of the plate for adequate penetration.



ACTIVITY

#59. Mastering a New Skill



#60. How-To Video

Horizontal V-groove butt joint instructions:

- Prepare appropriate bevels on plates for:
 - material less than 10mm thick only prepare one plate with a 30° bevel (image A). Tack-weld the plates together, leaving proper root spacing, with the beveled piece on top.
 - material more than 10mm thick prepare both plates with a 30° bevel (image B). Tack-weld the plates together, leaving proper root spacing.
- Secure plates in vertical position.
- Use a slightly smaller electrode for the root pass than for the fill passes.
- Hold the electrode with a 15-20° travel angle and similar to the angles shown here for each pass.
- Strike the arc and run the bead along the joint maintaining a short arc.
- Usually beads are laid in straight lines without any weaving motion. However, the cover pass (last pass), may be done with a weave if desired.
- Whenever possible, make welds from both sides.

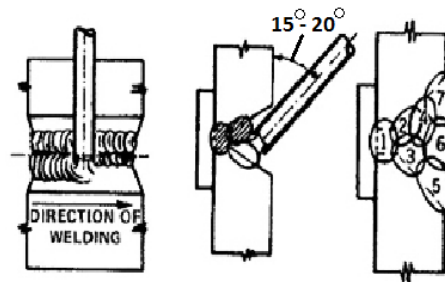
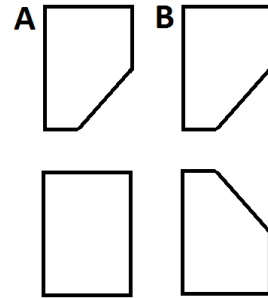

ACTIVITY

#59. Mastering a New Skill



#60. How-To Video

Vertical Welding

Vertical welding can be done using two different techniques: vertical-down welding and vertical-up welding. Just as their names imply, vertical-down welding starts at the top of the joint welding downward and vertical-up welding starts at the bottom of the joint welding upward. You may find that for yourself, one of these techniques is easier for you than the other. (Vertical-down is often found easier.) But there are times where it is more appropriate to use one over the other.

Hot Tip

Welding on a vertical surface is much more difficult than welding in flat or horizontal position due to the force of gravity. Gravity pulls the molten metal down. To counteract this force, make sure you use an electrode with fast-freezing characteristics.

Vertical-Down Welding

Less metal can be carried when making a vertical-down pass, so it is only recommended for welding metal that is 5mm or thinner. You could complete a joint on thicker metal using vertical-down but it would take many passes, which would be very time consuming and probably cause excessive distortion. Vertical-down welding usually does produce a smoother weld, so sometimes on the last pass, welders will cover a vertical-up weld with a vertical-down weld.

Vertical-down fillet weld (lap joint and T-joint) instructions:

1. Tack-weld two plates together to form joint that can be welded with a fillet weld.
2. Secure plates in vertical position.
3. Hold the electrode at a 60° angle to vertical plates, pointing upwards, and directed at a 45° angle into the joint.
4. Strike the arc at the top of the plates and weld down. For the first pass use a straight bead, a whipping motion or a small weave. The choice of which bead to use depends on your preference and how large you want the weld to be.
5. Keep a short arc while welding and travel downward at a speed that keeps the slag from running ahead of the crater.
6. Clean the first pass well and lay a second bead over it using a weaving motion. Be sure your weave is wide enough to cover the first pass and penetrates into the corners and

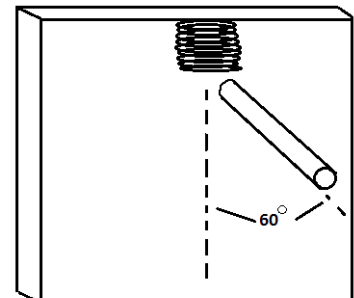

evenly into each plate. If making a lap joint take care to overheating the outside edge of the joint.



ACTIVITY

#59. Mastering a New Skill



#60. How-To Video

Vertical-down square butt joint instructions:

1. Since vertical-down is most suitable for thinner materials, normally only a square butt joint should be made welding down. Tack-weld two plates together to form desired square butt joint, leaving proper root gap.
2. Secure plates in vertical position.
3. Hold the electrode at a 60° angle up from the vertical plates, pointing directly into the joint.
4. Strike the arc at the top of the plates and weld downward. You'll probably have the most success using a whipping motion.
5. Keep a short arc while welding and travel downward at a speed that keeps the slag from running ahead of the crater. Ensure that the weld is penetrating at least half way through the joint and that the bead is fusing evenly to each plate.
6. Weld the reverse side of the plates in the same manner, ensuring beads meet in the middle of the plate for adequate penetration.

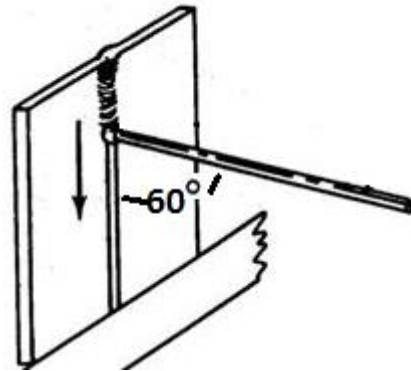

ACTIVITY

#59. Mastering a New Skill



#60. How-To Video

Vertical-Up Welding

Since deeper penetration is achieved and more metal can be carried with a vertical-up pass, it is usually used on plates 6mm or thicker. Because of these qualities, welds made with vertical-up require fewer passes which results in less distortion.

Welding with vertical-up requires a lower amperage setting than flat or vertical-down welding. The heat must be high enough to allow the puddle to spread out and get good penetration, but low enough to prevent run down and overheating.

Spark of Information

Most of the problems that occur while vertical-up welding are from improper amperage settings.

Vertical-up fillet weld (lap joint and T-joint) instructions:

1. Tack-weld two plates together to form a joint that can be welded with a fillet weld.
2. Secure plates in vertical position.
3. Hold the electrode nearly perpendicular to vertical plates, pointing upwards slightly, and directed at a 45° angle into the joint.
4. Strike the arc at the bottom of the plates and weld upwards. Lay the first pass using a whipping motion. The whipping motion allows the metal to solidify, preventing it from running downwards.

5. Clean the first pass well and lay a second bead over it using a weaving motion. Be sure your weave is wide enough to cover the first pass and penetrates into the corners and evenly into each plate. If making a lap joint take care to avoid overheating the outside edge of the joint.

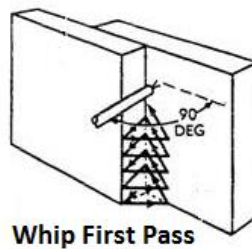

Whip First Pass

Use Weave on Remaining Passes

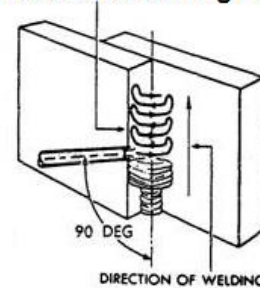

6. If desired, for a smoother finished bead, run your last pass either with a 7018 electrode or using a vertical-down pass.



ACTIVITY

#59. Mastering a New Skill



#60. How-To Video

Vertical-up V-groove butt joint instructions:

1. Prepare the plates identically to the way you would if welding in the flat position with appropriate bevels according to thickness of metal. Tack-weld two plates together to form desired V-butt joint, leaving proper root spacing. If desired, to make first pass easier, also tack on a backing strip.

2. Secure plates in vertical position.
3. Hold the electrode nearly perpendicular to vertical plates, pointing upwards slightly and directed straight into the joint.
4. Strike the arc at the bottom of the plates and weld upward. You'll probably have the most success using a whipping motion.
5. Clean the first pass well and lay a second bead over it using a weaving motion. Be sure your weave is wide enough to cover the first pass and penetrates evenly into each plate. The number of passes will depend on thickness of metal. Some joints may only require one pass to be welded correctly.

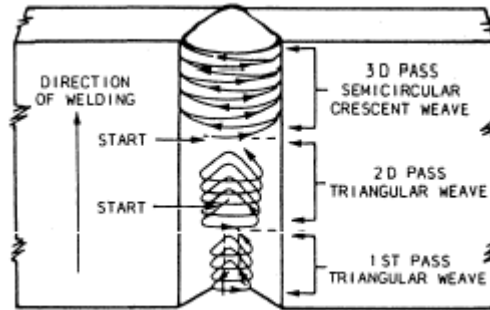

ACTIVITY



#59. Mastering a New Skill



#60. How-To Video

Overhead Welding

The overhead position is when welds are deposited on the underside of a joint. This welding position is the most difficult because you have to work against the force of gravity while depositing a weld bead. Plus, the majority of time you also have to assume an awkward, tiresome stance and contend with very hot falling debris. For these reasons, if you can avoid welding in the overhead position, do. It will always be easier to make a weld in any other position. However, in those instances when you have no other choice other than to weld overhead, it is definitely doable, especially now that you have practice and experience making good quality welds in other welding positions.

Even though making a uniform bead with sufficient penetration in the overhead position can be a tricky task, with practice it is possible to make welds that are equal in quality to those made in other positions. You can achieve this by holding a short arc and depositing the bead with a whipping motion which will help to keep the puddle small and avoid sagging.

To combat fatigue and keep a steady hand while welding in the overhead position try draping the cable over your shoulder if standing, or over your knee if sitting. If you don't disperse the

weight of the cable like this you will definitely tire sooner. Also try using both hands to hold onto the electrode holder and resting an arm or elbow on your body or a solid object to help you to steady the electrode.

You also need to take extra measures to protect yourself from falling spatter and sparks while welding overhead. Try to stand to one side of the bead and hold the electrode in such a way that the back of your hands are the first thing the spatter hits as opposed to your head, shoulders and neck. Be sure to button up the collar of your shirt to protect your neck and wear your skull cap to protect your head.

Overhead fillet weld (lap joint and T-joint) instructions:

1. Tack-weld two plates together to form a joint that can be welded with a fillet weld.
2. Secure plates in overhead position so that the underside is easily reached by the electrode.
3. Hold the electrode at a 30-45° angle to the vertical plate and tilted slightly (5-15°) towards the direction of travel. If the electrode is angled too far, the molten filler metal takes the heat instead of the base metal which causes the puddle to drip.
4. Strike the arc and establish a puddle evenly on both pieces. Place a bead in the corner of the joint using a whipping motion.

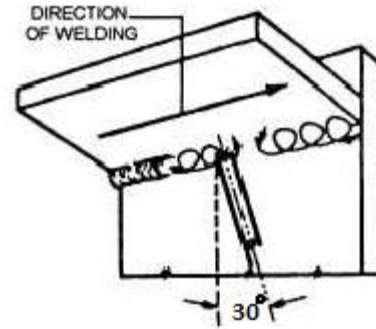

5. Keep a short arc while welding and use the speed of your whipping motion to prevent the bead from sagging.
6. Clean the first pass and, if multiple passes are necessary, lay multiple stringer beads in the same manner. If needed, these passes can be made with a slight weaving motion. If the joint only requires a two-pass weld, lay the second pass with weaving. If making a lap joint be sure that your last pass ties this outside edge in completely with the weld.

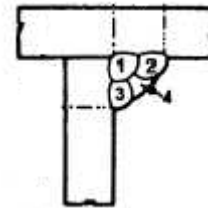

ACTIVITY



#59. Mastering a New Skill



#60. How-To Video

Overhead square butt joint instructions:

1. Tack-weld two plates together to form desired square butt joint, leaving proper root gap. (Remember, if the joint can only be reached from one side, you may have to weld it as a V-groove butt joint instead of a square butt joint to get adequate weld penetration.)
2. Secure plates in overhead position.
3. Hold the electrode pointing directly into the joint and tilted 15° in the direction of travel. If the electrode is angled too far, the molten filler metal takes the heat instead of the base metal causing the puddle to drip.
4. Strike the arc and run a stringer bead along the joint using a slight whipping motion. Maintain a short arc while welding and use the speed of your whipping motion to prevent the bead from sagging. Ensure that the weld is penetrating at least halfway through the joint and that the bead is fusing evenly to each plate.
5. Weld the reverse side of plates, which will normally be accessible to weld in flat position, ensuring beads meet in the middle of the plate for adequate penetration.

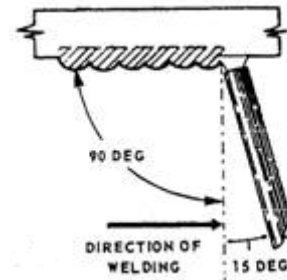

ACTIVITY



#59. Mastering a New Skill



#60. How-To Video

Overhead V-groove butt joint instructions:

1. Prepare the plates identically to the way you would if welding in the flat position to create beveled edges. Tack-weld the plates together to form desired V-butt joint, leaving proper root spacing. If desired, to make first pass easier, also tack on a backing strip. The backing strip will also help ensure the first pass has proper penetration.
2. Secure plates in overhead position.
3. Hold the electrode pointing directly into the joint and tilted 15° in the direction of travel. If the electrode is angled too far, the molten filler metal takes the heat instead of the base metal causing the puddle to drip.

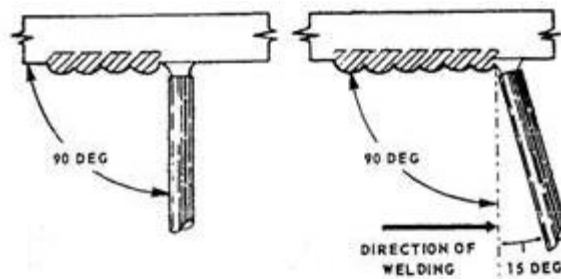

heat instead of the base metal causing the puddle to drip.

4. Strike the arc and run a stringer bead along the joint with a whipping motion. Maintain a short arc while welding and use the speed of your whipping motion to prevent the bead from sagging.
5. Clean the first pass and lay multiple stringer beads in the same manner with a whipping motion. The way you hold the electrode for multiple passes will depend on which pass you're laying. The sequence you lay the passes should look something like this.

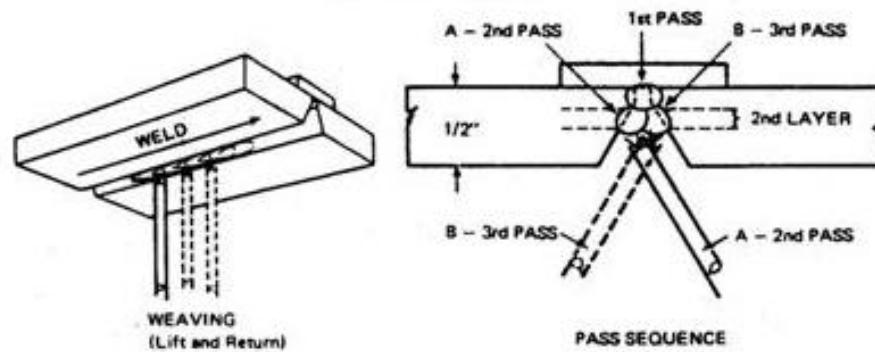

Unit 6 Resources

- <http://www.sweethaven.com/sweethaven/BldgConst/Welding/lessonmain.asp?lesNum=7&modNum=6>
- http://www.lincolnelectric.com/assets/global/products/consumable_stickelectrodes-mildandlowalloysteels-excalibur-excalibur10018-d2mr/c2410.pdf
- <http://www.sweethaven.com/sweethaven/BldgConst/Welding/lessonmain.asp?lesNum=3&modNum=3>
- <http://www.mig-welding.co.uk/arc-flat-joints.htm>

COMPLETE LIST OF UNIT 6 ACTIVITIES



#59. Mastering a New Skill



#60. How-To Video



#61. Larger than Life Dice

Unit 7

Perfecting Your Technique

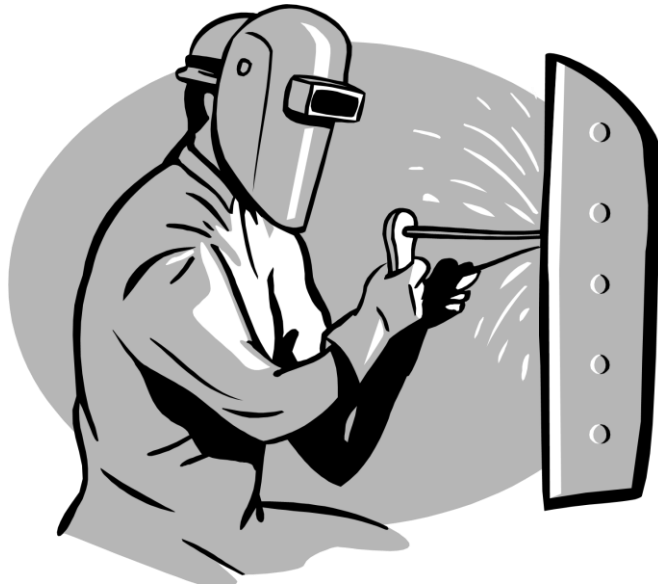

Bring with you to the meeting:

- Pen or pencil and notebook
- Clothes to weld in and safety gear (see appendix for the image of the well-dressed welder)

In this Unit we will:

- Look at the characteristics that make up a good weld.
- Find out how to test and inspect welds for quality.
- Learn how to solve our welding problems by looking them up in the “troubleshooting dictionary” and following the suggestions given.
- Talk about tips and tricks that can help us weld successfully every time.

CHAPTER 1: Making Good Welds

As a welder, every time you make a weld you need to ask the question, “Did I just produce a good quality weld?” The answer to this question should always be yes. If not, you need to figure out what you did wrong, correct your technique and make the weld again. If you know you’ve made a poor quality weld when working on your projects there is absolutely no harm in grinding out the weld you made and trying again. In fact, this is what you should do if you’ve made a weld that isn’t up to par.

But how do you know if the weld is good quality or not? Well for starters, it should look good from the outside. A good looking weld is smooth, has evenly spaced ripples and is uniform in size the entire way along. There is no burn through and the edges of the weld are feathered into the base metal. When a weld is good looking, it is a sign that care and good welding techniques were used to make it.

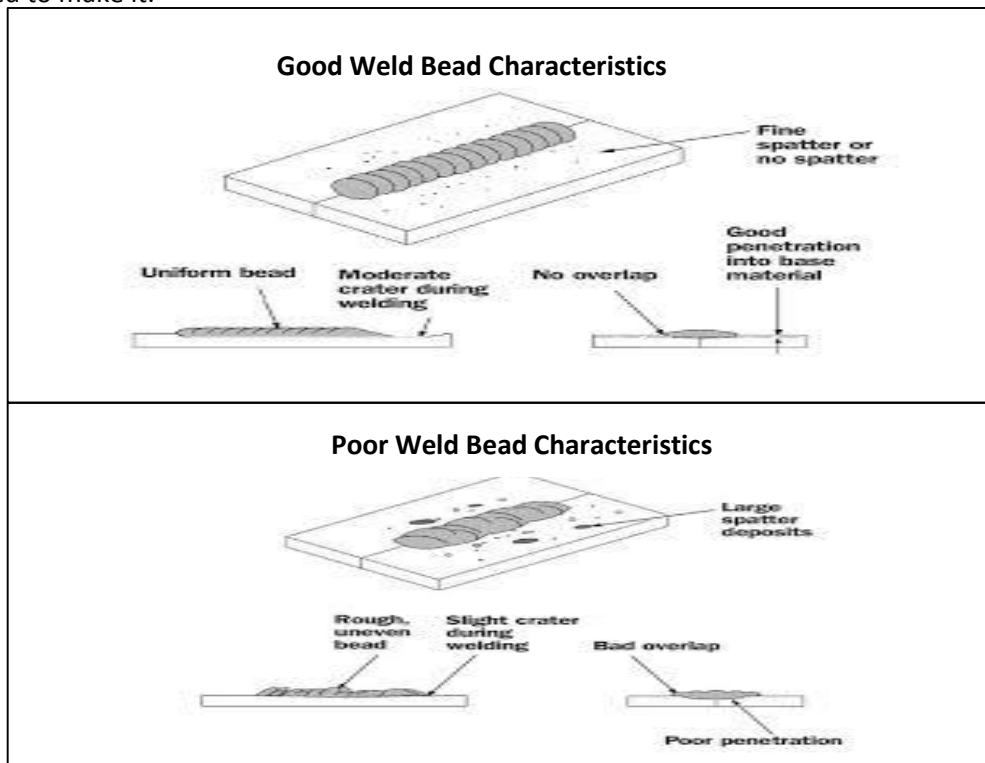

Don’t be deceived into thinking that a weld that looks good from the inside is a good weld through and through. Sometimes, even when our welds look perfect from the outside, they may have some major problems on the inside. These hidden problems can lead to weak welds that may break when stress is put on the joint or with wear and tear over time.

What really determines a good quality weld is adequate penetration and fusion. When you get these two things right, a good weld will be one that is as strong, if not stronger than the base metal surrounding it. This means that if force is applied to the joint, the base metal will most

likely break before the joint does. Even a beginner welder can consistently produce good welds of high quality by taking care when welding, using the correct techniques and properly preparing the weld before beginning.

There are a number of different methods that can be used to test welds for proper penetration and fusion. Some methods like x-rays and ultrasounds will leave a finished weld intact and some methods, like bend testing or sawing the joint in half, will destroy a welded joint. Most likely, the method that will be most accessible to you will be “destructive testing.”

Examples of destructive testing



As a beginner, performing tests on welds you’ve made to check for penetration and fusion is a very good idea. You don’t want to use destructive testing to test the joints of your actual project. Instead, you should weld practice pieces and then break them apart to inspect for quality. There is no other way to know if your practice and hard work has paid off!

ACTIVITY



#62. Whip It



#63. Back and Forth



#64. Strength Testing

CHAPTER 2: Troubleshooting

Sometimes, even when we think we've done everything right, welds just don't turn out the way they're supposed to. When this happens you need to troubleshoot to figure out what's gone wrong, why it's happened and what you can do to correct the situation. Since there are so many different factors that play a role in forming a good weld, troubleshooting can be a bit of a nightmare. What do you try doing first to fix the problem? Adjust arc length? Switch to a different electrode? Change the amperage setting? There are so many possibilities!

Thankfully, this chapter is here to help. It is a diagnostic dictionary. That means that when you are having troubles making quality welds, you should stop what you're doing, come here, look up the problem and then follow the suggestions given. You don't need to go through this entire dictionary right now. Just come here when you're looking for some troubleshooting help.

Diagnostic Dictionary

Arc Blow

Problem: The arc wanders while you're welding, refusing to go where it's supposed to go, spattering badly, and "blows" back or forward. If you've encountered arc blow while welding, you know that dealing with an unruly arc makes the molten puddle nearly impossible to control. Beyond making welding difficult, welds made when arc blow is present are poorer in quality because of things like poor fusion, porosity and slag inclusion.

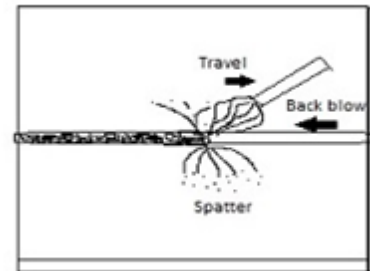

Causes: Every part of the welding circuit that carries current is surrounded by a magnetic field. Sometimes when using a DC power source the force of the magnetic field can be distributed unevenly around the arc causing arc blow. Arc blow is most often encountered when welding complex joints, in corners, deep grooves and at the beginning and end of joints.

Corrective Actions: There are a number of things you can try to get rid of arc blow.

- ✓ If you have the option, switch to AC. Arc blow does not happen when using AC.
- ✓ Change position of the ground clamp, placing it as far from the joint to be welded as possible.
- ✓ Weld towards a heavy tack or towards a weld that's already been made.
- ✓ Weld away from the ground clamp.
- ✓ Use back-stepping along welds.
- ✓ Use as short of an arc length as possible.
- ✓ Rearrange ground cables, coiling them on the ground.

- ✓ Wrap ground cable around your welding table or workpiece, perhaps even passing ground clamp through these coils.
- ✓ Reduce current.

Burn through

Problem: Weld metal melts completely through base metal leaving holes where no metal remains.

Causes: excessive heat

Corrective Actions:

- ✓ Select lower amperage.
- ✓ Use a smaller electrode.
- ✓ Increase and/or maintain steady travel speed.

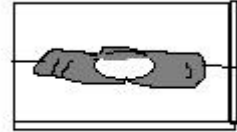

Cracked weld

Problem: Cracks appear in welds (usually after weld has cooled). Cracks are an indication of weld failure. Although some cracks are more serious than others, they are always a point of weakness.

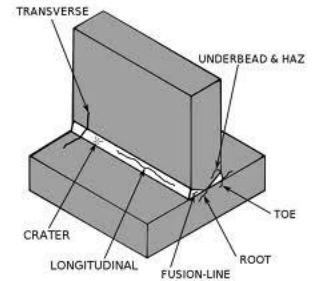

Causes:

- Incorrect electrode
- Poor fit-up/incorrect gap size
- Amperage too high
- Welds too small for size of parts being joined

Corrective Actions:

- ✓ Choose proper electrode for metal thickness/joint size.
- ✓ Ensure electrode is not damp.
- ✓ Establish proper gap size and good fit-up for pieces being welded.
- ✓ Ensure uniform gap all along joint.
- ✓ Use lowest amperage possible that will still create a sound weld.
- ✓ Adjust the size of weld to correspond with size of parts being welded.
- ✓ Make sure the weld bead is strong enough for the stresses on the joint caused by heating and cooling of welding process.
- ✓ Try using a weaving instead of a stringer bead to make a larger weld.

Craters improperly filled at ends of beads

- ✓ Properly fill craters at the end of each bead.

Poor quality base metal

- ✓ Try using a low-hydrogen electrode.

Distortion

Problem: Pieces that have been welded move as they cool, pulling themselves out of proper alignment. This is due to metal contracting as it cools down.

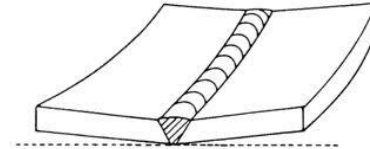

Figure 6-50. Distortion in a butt weld.

Causes:

Excessive heat input

Corrective Actions:

- ✓ Use lower amperage.
- ✓ Increase travel speed.
- ✓ Weld in small segments and allow cooling in between welds.
- ✓ Use minimum number of passes by weaving or using a larger electrode.

Improper welding sequence

- ✓ Before welding, develop a plan of attack on how you will complete the weld.
- ✓ Divide complicated welds into sub-assemblies.

Lack of anticipation of metal movement

- ✓ Use clamps to hold base metal in place.
- ✓ Make several tack welds along joint before welding.
- ✓ Set up the joint to allow for distortion movement.

Poor Fusion

Problem: Weld metal fails to fuse completely with base metal or previous weld bead. Poor fusion is a serious structural defect but often cannot be seen with the naked eye. It will show up in strength testing the weld.

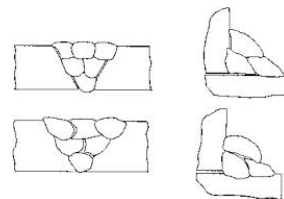

Causes:

Insufficient heat input

Corrective Actions:

- ✓ Increase amperage.
- ✓ Select larger electrode and increase amperage.
- ✓ Decrease weld speed.
- ✓ Widen groove to access bottom during welding or use smaller electrode that can reach into the groove.

Improper welding technique

- ✓ Place beads in proper location along joint.
- ✓ Adjust work angle and ensure arc is at leading edge

	of puddle.
	✓ When weaving, pause slightly at the edge of each weave pass.
Dirty workpiece or failure to clean beads between passes	✓ Clean all base metal that will be included in the weld joint well before welding by removing all grease, paint, dirt, etc.
	✓ Clean beads well between each pass, chipping off slag and brushing with a wire brush.
Arc blow	✓ See corrective actions under “arc blow” section.
Poor joint fit-up	✓ Ensure gap size isn’t too large.

Shallow Penetration

Problem: Weld metal deposited does not reach deeply enough into the base metal. Depth of penetration is usually not visible by looking at the outside of a finished weld. Penetration, or the depth the weld enters the base metal, is very important in creating a strong weld.

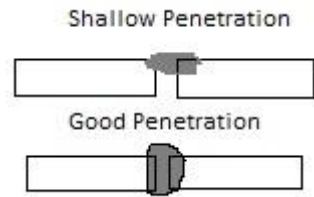

Causes:

Travel speed too fast

Electrode too large to fit in groove

Amperage too low

Improper joint preparation

Corrective Actions:

✓ Decrease to a speed that allows enough weld metal to be deposited.

✓ Use narrower electrode that can reach to the bottom of the joint.

✓ Increase amperage.

✓ If necessary, switch to an electrode with deeper penetrating characteristics.

✓ Leave the correct sized gap at the bottom of the weld and, if needed, use a backing strip on the root opening. When joining thicker material, bevel the edges.

Porosity

Problem: Small holes in the weld that are usually not visible from surface of the weld. Porosity is a result of gas pockets being trapped in the weld and can lead to cracking.

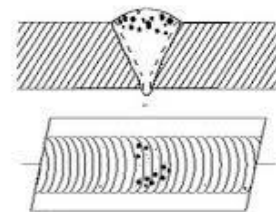

Causes:

Dirty workpiece

Corrective Actions:

- ✓ Clean all base metal that will be included in the weld joint before welding by removing all grease, rust, oil, mill scale, paint, dirt, etc.

Defect of electrode

- ✓ Make sure the electrode is dry.
- ✓ Chose an electrode that easily makes sound welds (like a **low-hydrogen electrode**).
- ✓ Do not use damaged electrodes.
- ✓ Be sure to be using the correct type of electrode for the metal you're joining.

Improper welding technique used

- ✓ Puddle the weld long enough to allow trapped gases to escape.
- ✓ Try using a weaving pass instead of stringer bead.
- ✓ Experiment with arc length to see if you need to make it longer or shorter.
- ✓ Try not to weld at an excessively fast speed.

Undercut

Problem: An unfilled groove is left below the surface of the base metal along the edge of the weld bead.

Causes:

Amperage too high

Corrective Actions:

- ✓ Lower the amperage.

Arc length too long

- ✓ Use a shorter arc length.

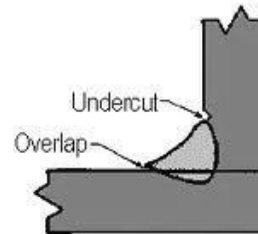

Improper electrode movement or position

- ✓ Avoid excessive weaving.
- ✓ Try to make weave as uniform as possible.
- ✓ Try not to weld too quickly.
- ✓ Make sure you use an electrode designed for the position you're welding in.
- ✓ Avoid letting an excessively large molten puddle form.
- ✓ When making a fillet, hold electrode further away from vertical plate.
- ✓ Adjust angle of electrode.

- | | |
|---------------------|--|
| Electrode too large | ✓ Use a smaller diameter electrode. |
| Arc blow | ✓ See corrective actions under “arc blow” section. |

Poor Weld Appearance

Problem: Weld bead has noticeable flaws that are visible by outwardly inspecting the weld. Flaws may or may not affect the strength of the weld.

Causes:

Corrective Actions:

- | | |
|--|--|
| Faulty or incorrect electrode | <ul style="list-style-type: none"> ✓ Make sure the electrode is dry. ✓ Do not use damaged electrodes. ✓ Be sure to be using the correct type electrode for the metal you’re joining and position you’re working in. |
| Improper electrode manipulation | <ul style="list-style-type: none"> ✓ Use a shorter arc length. ✓ Focus on making a uniform weave bead. |
| Improper welding technique | <ul style="list-style-type: none"> ✓ Travel at a constant speed. ✓ Adjust arc length and/or amperage setting. |
| Overheating | <ul style="list-style-type: none"> ✓ Lower the amperage. ✓ Travel more quickly. |
| Improper joint preparation | <ul style="list-style-type: none"> ✓ Take care when fitting up joints to leave even and correctly spaced gaps. ✓ Clean base metal well before starting. |
| Failure to clean beads properly between passes | <ul style="list-style-type: none"> ✓ Remove all slag, flux and spatter from weld bead and adjacent base metal before running more passes. |
| Unsteady hand (if bead is wavy) | <ul style="list-style-type: none"> ✓ Use two hands to steady yourself, resting one elbow on your welding table. |

Spatter (excessive)

Problem: Small pieces of weld material scatter and splash while welding. Once cooled these scattered pieces form small bumps on base metal that are not part of the weld. Spattering is not a structural fault, but can indicate that you are making a weld that does have some structural weaknesses.

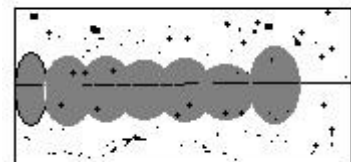

Causes:

Amperage too high
Using wrong polarity

Arc blow
Wrong electrode

Arc length too short
Incorrect electrode angle

Corrective Actions:

- ✓ Lower the amperage.
- ✓ Switch polarity, making sure to use the one your electrode is designed for.
- ✓ See corrective actions under “arc blow” section.
- ✓ Some electrodes spatter more than others, choose one with less spattering characteristics.
- ✓ Electrode may be too large, choose one with a smaller diameter that corresponds with thickness of material being welded.
- ✓ Ensure you are using the correct electrode for polarity being used.
- ✓ Be sure electrode is dry.
- ✓ Use a longer arc length.
- ✓ Experiment with different angles.

Slag Inclusion

Problem: Pieces of slag become stuck in weld while welding and cannot be removed. Slag inclusion can either be visible from the surface or hidden inside of the finished weld bead.

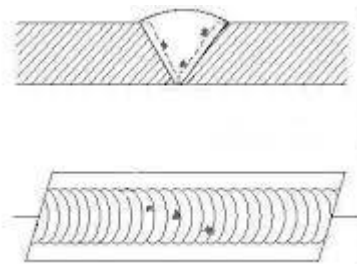

Causes:

Amperage too low
Dirty workpiece
Lack of care when making multiple passes
Faulty electrode
Arc length too low

Corrective Actions:

- ✓ Raise the amperage.
- ✓ Clean base metal that will be included in the weld joint well before welding, removing all grease, rust, oil, mill scale, paint, dirt, etc.
- ✓ Remove all slag, flux and spatter from weld bead and adjacent base metal before running more passes.
- ✓ Plan weld sequence in advance and make passes in correct order.
- ✓ Be sure electrode is dry and free from damage.
- ✓ Use shorter arc length.

Improper welding technique	<ul style="list-style-type: none"> ✓ Adjust electrode angle. ✓ Travel at a correct and even speed. ✓ Take care when weaving to make sure the puddle doesn't solidify before you've tied it in with the next weave.
Electrode too large to fit in groove	<ul style="list-style-type: none"> ✓ Use narrower electrode that can reach to the bottom of the joint.

Warping

Problem: Thin pieces that have been welded bend and twist out of shape.

Causes:

Excessive heat input

Lack of anticipation of metal movement and improper fit-up

Corrective Actions:

- ✓ Use a high speed electrode with moderate penetrating characteristics.
- ✓ Use lower amperage.
- ✓ Increase travel speed, welding as quickly as possible when welding thin material.
- ✓ Weld in small segments and allow cooling in between welds.
- ✓ Use minimum number of passes (by using weaving or a larger electrode).
- ✓ Use clamps to hold pieces in place.
- ✓ Do not leave excessive gap between parts being welded.
- ✓ If necessary, hammer metal around the joint thinner before welding; this will elongate the metal around the joint so that when its welded it will contract to desired size.
- ✓ Use a back-up bar.

Sluggish Arc

Problem: Arc is not powerful enough to properly weld with.

Causes:

Amperage too low

Poor connection somewhere in the circuit

Corrective Actions:

- ✓ Increase amperage.
- ✓ Check all components of welding circuit to make sure they're properly connected (electrode holder and cable, ground clamp and cable, etc.).

Using incorrect size
cable

- ✓ Check that you are using a cable that is the right size (diameter) and length for job at hand.



ACTIVITY

#65. Fault Finding



#66. Good vs. Bad

CHAPTER 3: Tips n' Tricks

Still having troubles making the perfect weld? Don't worry. Making a quality weld is often easier said than done. It can be tricky and time consuming. Sometimes it feels as if it would just be easier to make a bad weld than take the time to make a good one, but that is never the case. Doing so will just result in your welds coming apart or breaking in the future. In the long run, making quality welds are always well worth the effort.

Below is a list of tips that will help you make quality welds. When you feel like your welds aren't up to snuff or if your strength testing reveals some flaws that you can't seem to resolve you can come here to review this list. Hopefully you'll find a tip or two that will help you improve the quality of your welds.

- Keep in mind that every welding machine welds a little differently. Even two identical machines may have slight differences in how they weld. So try to use the same machine as much as possible and keep in mind that when you do switch machines the settings you used with one machine may not be the exact ones you need to use with another machine.
- Experiment with speed, arc length, travel angle and amperage even after you think you have found the best to do the job. You may find an even better way!
- Avoid building up more weld material than necessary. Building up more weld bead beyond what you need doesn't add any strength to the weld, it just takes longer and puts more heat into the metal.
- Allow the weld to cool slowly. Do not quench your workpiece and leave the slag on as the weld cools.
- When making multiple passes make sure that each bead partially covers the one before it so they are all fused together well.
- Take care to properly fit up joints. Use clamps, vise grips, right angle magnets and tack-welds to properly position the metal. If leaving a gap, make sure it is a uniform size the entire way along.
- Be sure to chip the slag and clean each bead before laying another one over top of it. A sign that a weld is well-made is when the slag comes off quite easily.
- Examine the weld when finished. If it has any defects remove the weld with a grinder and start again. Or, if you know that you've made an error that will leave a hidden defect in your weld, grind it out and run a new one. **Never attempt to weld over a cracked or porous weld.**
- Welding is a skill that requires a lot practice to perfect. Practice, practice and more practice will help you gain experience, which is probably the best thing you can do to improve your welding.
- If the sides of the bead aren't tied in properly to the base metal you may be moving too fast, jamming the rod into the puddle or using an amperage that is too low.

- Everybody welds a little differently, so if you get the chance, watch other welders at work. Seeing how different welders complete a weld can help you to develop a successful style and rhythm of your own.
- Try using a different electrode (one with a different number). You may be surprised to find out that welding with one electrode is easier or more difficult than another.
- Make sure you choose an appropriate electrode for the metal type and job at hand. When welding out of position make sure that you are using fast-freeze electrodes.
- Thoroughly clean the base metal before welding removing dirt, grease, paint, etc. If you don't clean the plate properly these things can be included in the weld, making it weak. If needed, you can use a grinder to help you clean off rust and paint.
- Whenever possible, weld in the flat position instead of out of position. The easiest way to make a quality weld is to have the work lying flat because the work is less tiring, welding speed is faster, the molten puddle is less likely to run and better penetration can be achieved.
- When you are forced to weld out of position, it is helpful to use lower amperage and a shorter arc length than what you would for welding the same joint in the flat position.
- When making multiple passes, try to build the weld up evenly as you go along. If you do end up with peaks and valleys it's easier to level them with a grinder than it is to fix with the next bead.

Unit 7 Resources

- <http://www.sweethaven.com/sweethaven/BldgConst/Welding/lessonmain.asp?lesNum=7&modNum=13>
- <http://www.weldguru.com/weld-troubleshooting.html>
- <http://www.lincolnelectric.com/en-us/support/welding-how-to/Pages/high-quality-stick-welds-detail.aspx>
- <http://deltaschooloftrades.com/stick%20essentials.htm>
- <http://www.thefabricator.com/article/arcwelding/smaw-a-welders-guide>
- http://www.customclassictrucks.com/techarticles/1307_mig_welding_tricks_tips_and_proper_techniques/photo_15.html
- http://commons.wikimedia.org/wiki/File:Welding_cracks.svg
- <http://www.ndt.net/article/wcndt00/papers/idn403/idn403.htm>
- [http://isadikin.wordpress.com/2006/08/27/weld-defects/`](http://isadikin.wordpress.com/2006/08/27/weld-defects/)
- <https://www.ndeed.org/EducationResources/CommunityCollege/Radiography/TechCali brations/RadiographInterp.htm>

COMPLETE LIST OF UNIT 7 ACTIVITIES



#62. Whip It



#63. Back and Forth



#64. Strength Testing



#65. Fault Finding



#66. Good vs. Bad

Unit 8

Wrapping Up

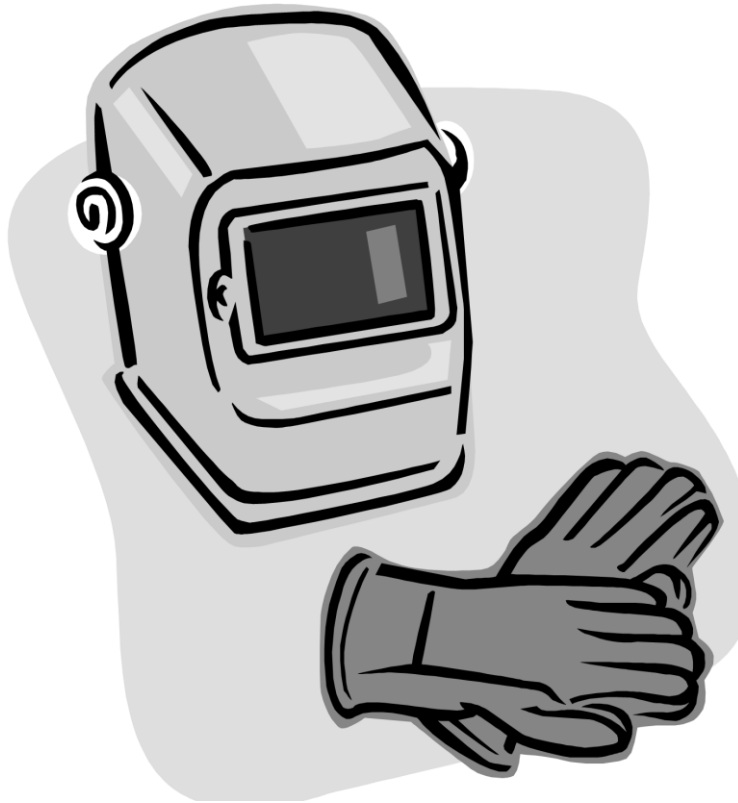

Bring with you to the meeting:

- Pen or pencil and notebook
- Clothes to weld in and safety gear (see appendix for the image of the well-dressed welder)

In this Unit we will:

- Talk about Achievement Day and put the finishing touches on our projects.
- Learn about judging and explore useful judging techniques.
- Reflect on the year and look at our future in welding.

CHAPTER 1: Getting Ready for Achievement Day



Achievement Day is an exciting part of the 4-H year. It is an opportunity for us to show off our accomplishments and all of the work we've done over the year to our fellow club members, our families, our friends and our community. Beyond recognizing our own accomplishments, Achievement Day is also about evaluating our project work, demonstrating to the public what 4-H is about and giving recognition to sponsors and other who have helped out the club in a special way.

We've actually been getting ready for Achievement Day since our very first meeting by learning new skills, completing activities and working on our projects. Now is the time to put the finishing touches on everything so that we are putting our best foot forward on Achievement Day.

If there were any activities that you didn't complete fully that will be displayed at Achievement Day, now is the time to go back and finish them. Just as you would never sell an unfinished project to a client, you should take pride in your work and finish it to the best of your ability before displaying it.

That being said, if you are working on one of your big individual projects and did not have time to finish it before Achievement Day, make a sign to be displayed with it that says "work in progress." By doing so, you are still allowing the public to appreciate what you've been working on throughout the 4-H year, while at the same time are letting them know that what they are seeing isn't the finished product.

To prepare all of your projects and **weldments** for Achievement Day you will want to smooth rough edges by filing, sanding and/or grinding. You should eliminate imperfections like spatter in the same way. Where appropriate, you may also want to paint your projects. Painting not only makes our projects more aesthetically pleasing, but also prevents them from rusting.

When getting projects ready for Achievement Day think about it as if you were getting all of your projects ready to be sold. What a consumer would rather purchase: a weldment that has sharp, unfinished edges and spatter everywhere, or one with a smooth finish that not only looks great, but feels good to the touch? This type of thinking brings us to another very important aspect of Achievement Day... judging!

CHAPTER 2: Judging

Judging is an important part of Achievement Day because it is an important part of our lives. There isn't a day that goes by that we don't judge because judging is how we make informed decisions and how, as consumers, we choose the best products for our needs. Just think about all of the judgments we make all day long; we make judgments when we decide what we are going to wear, what we will have for breakfast, how we will style our hair... and that's only within the first 30 minutes of being awake! We also use judging when making really important decisions such as choosing which career path to follow.

Practicing judging in 4-H helps us to:

- Appreciate the opinions of others.
- Improve our own work.
- Recognize good products and choose articles based on their quality.
- Become more observant.
- Learn how to assess the positives and negatives of a situation.
- Make our own decisions.
- Communicate our ideas clearly so others can understand.

In 4-H, judging requires members to examine a group of four items and to rank these items by comparing them to an "ideal" and to each other. All items that are in this group for comparison are called a class. Once members have decided on the ranking, or placement, of the class they must give reasons to support why the decision was made.

For successful judging, we can use the steps below to compare and evaluate the articles in each class. These steps can be applied to any class, from weldments to food to livestock. We can even use these steps in life after 4-H to help make our decision; only the number of options to consider and how/if we present our decisions will vary.

1. **Picture the ideal item** – Picture the ideal item in your mind. What does the perfect fillet weld look like? What about the perfect pizza? In your mind, or even on a sheet of paper, list the characteristics that you feel are important in a perfect item. Then rank these characteristics in order of importance.
2. **Think comparatively** – Judging determines the advantages of one item over another. So you need to think comparatively when looking at the items in a class; compare each item in the class with the other items and with your ideal item. As you examine the class thing about comparative terms you might use in your reasoning.

Hot Tip

A 4-H judging class will always have four items to compare. The items are numbered 1 to 4 from left to right.

Comparative terms are words ending in “er” and phrases with more in them. For example, one weldment may have more penetration and straighter weld beads than another. Or one pizza may have more cheese and a thicker crust than another. Try to keep your comparative terms positive.

3. **Examine** – First, examine the class from a distance. Stand back so that you can view all items in the class at the same time. This makes it easier to view overall appearance, size and structure and compare them against one another. Next examine the items closely. Inspect each one individually, continuing to compare them against all of the others and the ideal. If you are judging small items, feel them, pick them up, turn them over and look at them from all angles. Look closest at the characteristics you ranked most important first, as this is what you will base the placing of the class on.
4. **Make your decision** – Place items in order from most desirable to least desirable. The item that most resembles the ideal will be placed first, the next closest to the ideal second and so on for the four placings. Make your easiest placing first. For example, it’s often easiest to select the top and bottom placings first and then decide on the middle placings. If you have doubts go back and re-examine the items to confirm your decision. Remember, your first impression is usually best, so try not to second guess yourself. Take time to picture each item clearly in your mind so that you will remember its features when it comes time to back up your decision. If needed take notes.
5. **Tell why** – Give reasons to support your decision. Use comparative words in your reasoning and stay positive, pleasant and precise. Everyone else judging the same class may not have placed the items in the same order as you did. This is perfectly okay. Your reasons, and being able to back up your placement, is what’s really important.

CHAPTER 3: That's a Wrap

Congratulations, you've completed a year of Arc Welding!

Do you remember how, in Unit 1, we learned that welding touches almost every aspect of our everyday lives? This means that the world of welding is so vast, diverse and interesting that we've only just got our feet wet.

The great part of having learned how to arc weld is that you now have a solid set of welding skills. You can apply these skills to any other welding process and build upon them with more training and practice. If you are interested in more training, at the end of this Unit there is a list of colleges and trade schools in Saskatchewan that offer welding programs.

Are you wondering where welding can take you in life? The opportunities are endless! Welding students have a unique opportunity to learn a career that can be shaped around their interests. There is a welding niche for nearly every area of interest: working indoors or outdoors, staying close to home or travelling, science or art, research or sales, teaching or designing, robotics or computer programming, engineering or farming.

If you're considering a career in welding, do some digging around: talk to welders, do internet searches, subscribe to welding magazines. You may be surprised when you hear more about the incredible variety of welding jobs out there and how well they can pay. And be sure to check out the website for the Canadian Welding Association. They have some great videos available (see resources) that show how rewarding a career in welding can be!

Unit 8 Resources

- <http://www.4-h.sk.ca/plugins/userData/Info%20Sheets/Planning%20Achievement%20Day.pdf>
- <http://www.gov.ns.ca/agri/4h/awareness/planning.shtml>
- <http://www.gov.ns.ca/agri/4h/judging/howtojudge.pdf>
- <http://www.4-hontario.ca/uploads/userfiles/files/judging%20toolkit.pdf>
- http://www.thejudgingconnection.com/pdfs/Learning_Through_Judging.pdf
- <http://mason.ext.wvu.edu/r/download/149451>
- <http://www.careersinwelding.com/students.php>
- <http://www.cwa-ac.org/education.html>
- <http://www.livingin-canada.com/salaries-for-welders-canada.html>
- <http://www.cwa-ac.org/video.html>
- <http://www.cwa-ac.org/saskaton.html> or <http://www.cwa-ac.org/regina.html>
- http://www.youtube.com/watch?feature=player_embedded&v=N1za61qLcVA
- http://www.youtube.com/watch?v=YuKDH4NtKjg&feature=player_embedded
- http://www.youtube.com/watch?feature=player_embedded&v=DFbJwBwBLnU&list=UUVbLbc7goDa6FxaueyUHA#at=127

Schools That Offer Welding Programs in Saskatchewan

Carlton Trail Regional College – <http://www.ctr.c.sk.ca/programs>

Great Plains College – <http://www.greatplainscollege.ca/>

North West Regional College – <http://www.nwrc.sk.ca>

Northlands College – <http://trainnorth.ca/>

Parkland College – <http://www.parklandcollege.sk.ca>

Saskatchewan Indian Institute of Technologies – <http://www.siiit.sk.ca>

Saskatchewan Institute of Applied Science and Technology – <http://gosiast.com/>

Southeast Regional College – <http://www.southeastcollege.org>

Appendix

The Well-Dressed Welder
Tables
Activity Worksheets
Project Picker
Welding Terms
Resources
Acknowledgements

THE WELL-DRESSED WELDER

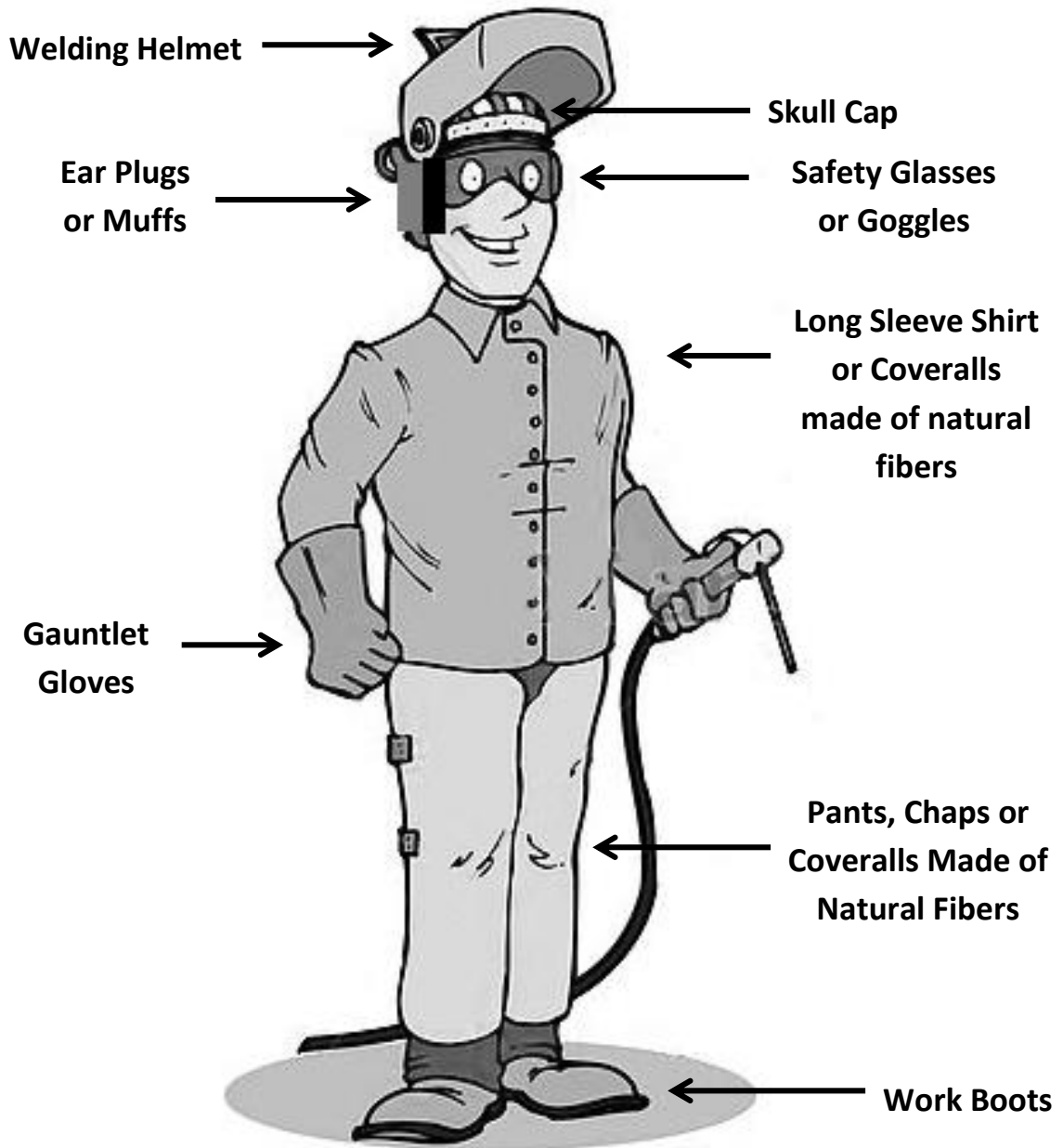

TABLES

Table 1 - Guide for Filter Shade Selection

Guide for Filter Shade Selection				
Operation	Electrode Size (mm)	Arc Current (A)	Min Shade	Suggested Shade
Shielded Metal Arc Welding	< 2.5 mm	< 60	7	*
	2.5-4 mm	60-160	8	10
	4-6.4 mm	160-250	10	12
	> 6.4 mmm	250-550	11	14

*As a rule of thumb, start with a shade that is too dark to see the weld zone. Then go to a lighter shade which gives sufficient view of the weld zone without going below the minimum.

From this chart, you can see that welding operations with a higher arc current or amperage need a darker filter than ones with lower amperage. This is because the higher amperage, the more intense and bright the light given off is.

Table 2 – AWS A5.1 Carbon Steel Electrodes for SMAW

E6010

E = Electrode

60 = Min. Tensile (in ksi)

1 = Position

0 = Type of Coating and Current

Key to Type of SMAW Coating and Current		
Digit	Type of Coating	Current
0	High Cellulose Sodium	DC+
1	High Cellulose Potassium	AC, DC±
2	High Titania Sodium	AC, DC-
3	High Titania Potassium	AC, DC±
4	Iron Power, Titania	AC, DC±
5	Low Hydrogen Sodium	DC+
6	Low Hydrogen Potassium	AC, DC+
7	High Iron Oxide, Iron Powder	AC, DC±
8	Low Hydrogen Potassium, Iron Powder	AC, DC±

ACTIVITY WORKSHEETS

1. Meet, Greet and Goals Worksheet
2. WHMIS I.D. Worksheet
3. The Shop Rules
4. Learn the Lingo Crossword
5. Learn the Lingo Word Search
6. Learn the Lingo Word Match
7. Name that Part Fill-in-the-blank
8. Good Weld Cheat Sheet
9. End-of-Year Reflection Worksheet

Meet, Greet and Goals Worksheet

Name: _____

Have you ever welded before? _____

If so, what have you done? _____

Why are you interested in welding? _____

What are five things you hope to learn by taking this project?

- 1** _____
- 2** _____
- 3** _____
- 4** _____
- 5** _____

WHMIS I.D. Worksheet

Draw lines to connect each image to its correct definition.



- a. Compressed gas
- b. Flammable and combustible material
- c. Materials causing immediate and serious toxic effects
- d. Bio hazardous infectious material
- e. Materials causing other toxic effects
- f. Corrosive material
- g. Dangerously reactive material
- h. Oxidizing material

The Shop Rules

- 1 _____
- 2 _____
- 3 _____
- 4 _____
- 5 _____
- 6 _____
- 7 _____
- 8 _____
- 9 _____
- 10 _____
- 11 _____
- 12 _____
- 13 _____
- 14 _____
- 15 _____
- 16 _____
- 17 _____
- 18 _____
- 19 _____
- 20 _____

Learn the Lingo Crossword

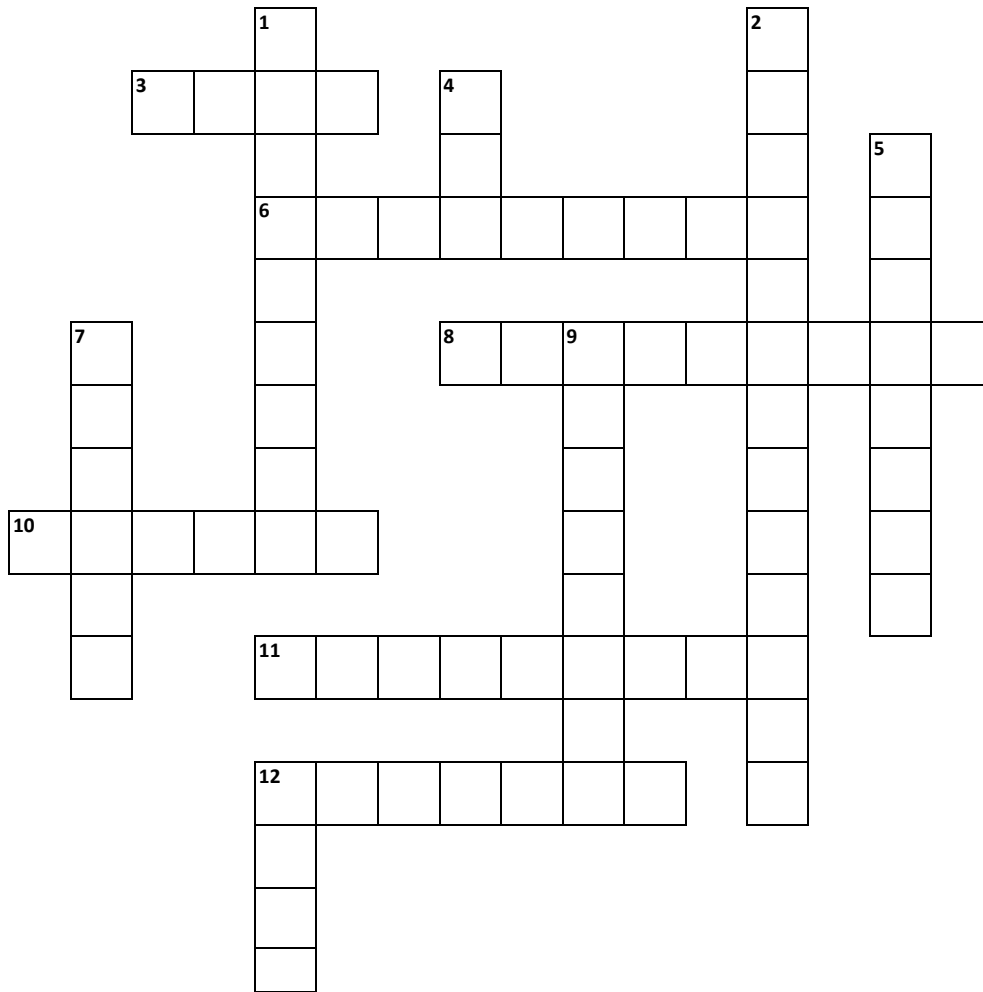

Across

3. The coating found on the outside of the electrode.
6. The metal rods used in arc welding, made of wire core and flux coating.
8. This is used to mark areas to be welded so that they can be seen while helmet is on.
10. Wear this to protect your eyes from harmful rays while welding.
11. The name for types of materials that can easily catch on fire.
12. Another name for the electrode holder.

Down

1. The visible column of fume that rises from the spot being welded. (2 words)
2. DC stands for this. (2 words)
4. The bright spark caused by electricity jumping between electrode and base metal.
5. Type of long gloves to be worn while welding.
7. Use these to pick up hot pieces of metal.
9. The amount of electrical current that flows through a circuit.
12. The waste material left on the weld that must be chipped off.

Learn the Lingo Word Search

s	e	f	u	m	e	p	l	u	m	e	e	d	w
h	s	g	w	e	l	d	e	r	d	a	e	b	e
s	e	l	b	a	c	t	a	e	e	r	e	w	l
s	s	l	a	y	y	n	u	d	g	p	l	i	d
l	s	t	m	g	c	e	o	e	a	l	g	r	i
e	a	t	i	e	y	r	a	l	r	u	g	e	n
l	l	t	l	t	t	r	r	r	e	g	t	b	g
y	g	s	e	c	u	u	c	e	p	s	a	r	c
b	y	p	e	m	d	c	l	g	m	e	h	u	i
n	t	l	a	t	e	m	e	s	a	b	a	s	r
r	e	m	m	a	h	g	n	i	p	p	i	h	c
y	f	l	u	x	h	r	g	e	g	w	c	c	u
c	a	c	d	c	e	u	t	e	l	w	e	a	i
r	s	y	p	m	l	h	h	a	s	f	e	s	t

acdc

amperage

arc length

base metal

bead

cables

chipping hammer

current

duty cycle

earplugs

electrode

flux

fume plume

helmet

metal

safety glasses

slag

welder

welding circuit

wire brush

Learn the Lingo Word Match

Match the correct words to their definitions.

- | | |
|-----------------------|--|
| _____ Duty cycle | A. The shaded lens in a helmet that protects your eyes from arc rays. |
| _____ Welding table | B. This is used to chip slag off of weld beads. |
| _____ Ventilation | C. The number of minutes a welder can be operated for without needing to cool down. |
| _____ Natural | D. The movement of air through a workplace to keep harmful fumes and gases away from welder. |
| _____ Welder's flash | E. The power source for arc welding. |
| _____ Filter lens | F. The part of the welding circuit that attaches to the base metal or welding table. |
| _____ Ground clamp | G. The electrical path in welding where the current flows. |
| _____ Auto-darkening | H. You place a workpiece on this metal surface to do all of your welding. |
| _____ Chipping hammer | I. Condition that occurs when eyes are exposed (even briefly) to the light emitted by arc. |
| _____ Base metal | J. The metal or alloy being welded. Also called workpiece. |
| _____ Welding circuit | K. The type of helmet that darkens as soon as an arc is struck. |
| _____ Welding machine | L. The type of material that a welder's clothing must be made out of. |

Name that Part Fill-in-the-Blank

Welding Circuit

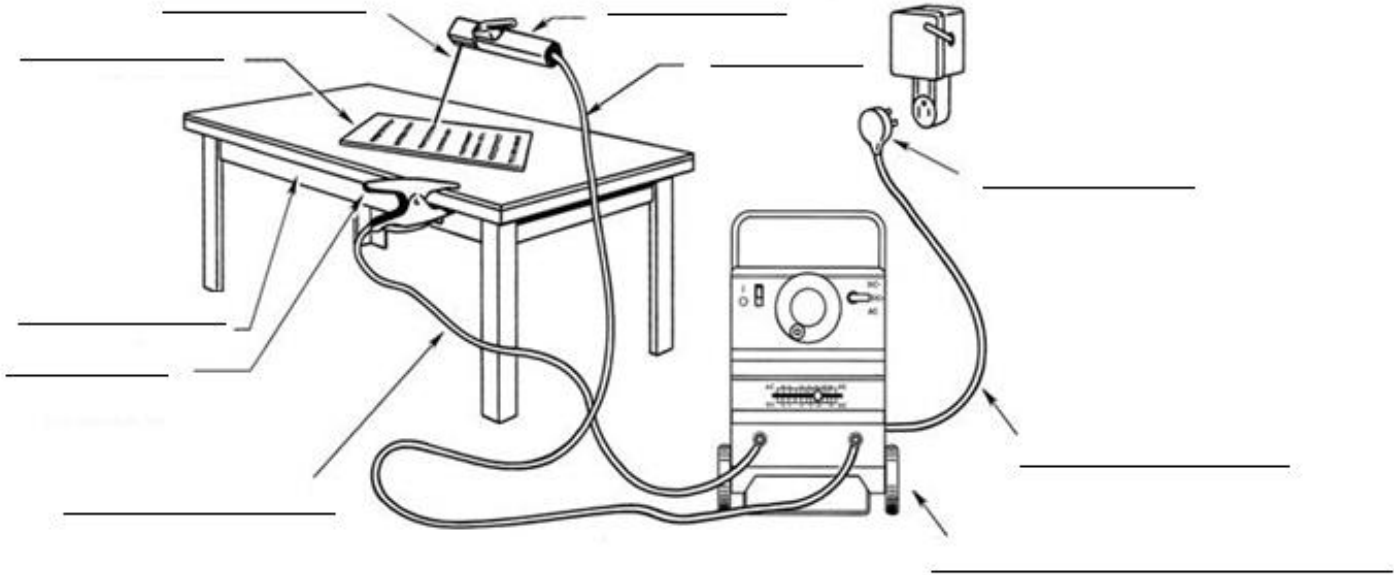

Welding Machine

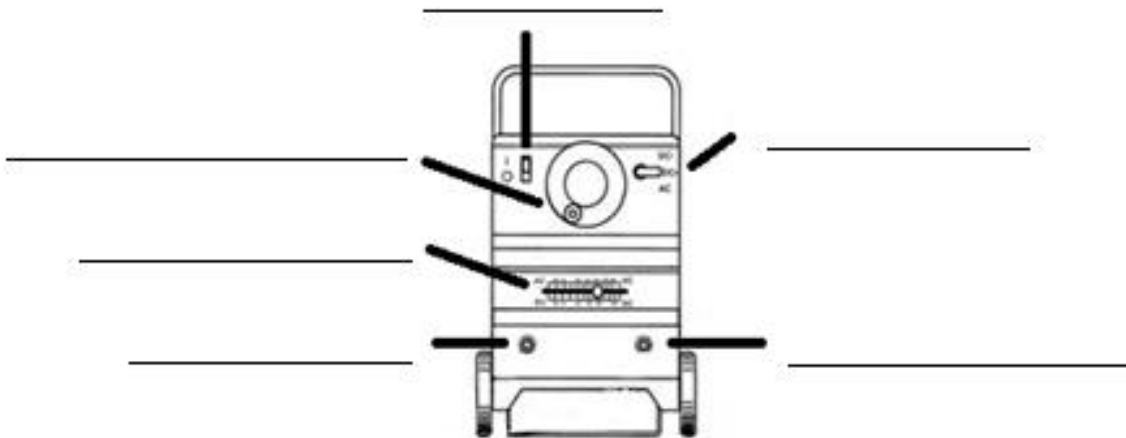

Good Weld Cheat Sheet

If the bead is...	If the bead is...
...the arc length is too short	...the arc length is too long.
If I hear a _____ sound the arc length is correct.	
If I hear a _____ sound the arc length is too short.	
If I can see the arc "jumping around" the arc length is _____.	

When running a stringer bead you should hold the electrode so that the arc force will push the puddle in a way that the weld will _____.
The correct travel angle for running a stringer bead is _____.

If the bead...	If the bead...
...the amperage is too low.	...the arc length is too long.
If I see charring on electrode's flux or if I burn through the base metal the amperage is _____.	
If it is difficult to strike the arc the amperage is _____.	

If the bead...	If the bead...
...the travel speed is too slow.	...the travel speed is too fast.
If my beads are not uniform I am not travelling at a _____ speed.	
If I burn through my work I am travelling _____.	

End-of-year Reflection Worksheet

Name: _____

What are five things you learned while taking this project?

1 _____

2 _____

3 _____

4 _____

5 _____

What part of this project did you find most interesting? _____

If you took this project again, what would you like to do differently? _____

PROJECT PICKER

Every member should complete one individual project and assist in one community project as part of their Achievement Day requirements. This section of the manual provides a list of project ideas, as well as some project plans (which includes a list of materials needed, shop drawings and instructions).

All project ideas whose plans are included in the “Project Plans” part of this manual are indicated by ***. Due to the source of the plans, measurements are given in imperial instead of metric. To convert inches to millimetres multiply the measurement by 25.4 (The term “Schedule 40” in these plans indicates the nominal wall thickness for standard black iron pipe.)

Some project ideas also have an internet website address underneath them. At the time that this manual was printed, these website contained useful plans that could be adapted into welding project plans.

For the project ideas that do not have plans, library books and the internet can both be valuable resources for you to find existing plans or develop your own plans. You may find it difficult to locate an actual step-by-step plan with material lists and shop drawings, like the ones provided in this section. However, if you do an internet search of any of these project ideas you will find many images that you can use as inspiration in your own designs. If developing your own project plan, before you begin working on the project you should hand draw a shop drawing, make a list of materials needed and write out the steps that you will take to complete it.

Spark of Information

Having trouble finding images of the project you'd like to work on? Adding the word “metal” into your internet search (i.e. searching for “metal garden bench” instead of “garden bench”) may give you better results

At the time that this manual was printed, the following websites had a multitude of project plans and ideas:

- <http://freeplans.domerama.com/>
- <http://www.millerwelds.com/interests/projects>
- <http://www.wcwelding.com/welding-plans.html>
- <http://www.lincolnelectric.com/en-ca/support/welding-projects/Pages/welding-projects.aspx>

Community Projects

Community projects will be completed by the entire club or in small groups. Following is a list of ideas for projects that you may want to consider as community projects. When picking a community project try to think of your community and how you could be of best service to the people who live there. For example, is there a spot where seniors might want to stop for a rest? If so, a garden bench would be perfect there. Are there community buildings that lack wheelchair access? Making a building accessible to everyone that uses the buildings would be greatly appreciated. Are there locations that are frequented by families? Bicycle racks would be a great addition to these locations.

Community Project Ideas

Bicycle rack

- <http://hostesswiththetozes.com/2012/04/29/project-4-diy-bike-rack-made-from-pvc-pipe/>
- <http://weldingweb.com/showthread.php?t=33211>
- <http://bikeracked.com/triangle-bike-rack-plans/>

Picnic table

- <http://ana-white.com/2010/04/furniture-plans-full-size-picnic-table.html?page=10>
- <http://www.curbly.com/users/rebekah-greiman/posts/13975-how-to-build-an-extra-large-diy-picnic-table>

Pitching screen

- <http://www.lincolnelectric.com/en-us/support/welding-projects/Documents/build-a-pitching-screen.pdf>

Garden bench

- <http://www.wcwelding.com/garden-bench-plans.html>

Wheelchair ramp

- <http://www.lincolnelectric.com/en-ca/support/welding-projects/Pages/wheelchair-ramp-detail.aspx>

Do you have any project ideas that are not included in this list that you think would benefit your community in some way? If so, bring them up at the meeting. Your idea could be just what your community needs!

Individual Projects

Below is a list of ideas for your individual project. Make sure you discuss with your leader which project you would like to do before making your final choice. It's better to pick a smaller project that you and your leader think you will have time to complete rather than pick a large project that will not be finished in time for Achievement Day. The great thing about picking a smaller project is that if you finish it you can start working on a second project of your choice! That being said, if this is your second or third time taking this project, you may have time to complete a larger more complex project.

Individual Project Ideas:

Fire pit

Welding table

- http://www.mylincolnelectric.com.au/knowledge/articles/content/howto_weldingtable.asp

Christmas tree stand***

Post driver***

Shop stool

- <http://www.millerwelds.com/interests/projects/shop-stool>

Bookends

Tomato cage

Ornaments for gardens/outdoors

Boot scraper***

Trailer

- <http://www.lincolnelectric.com/en-ca/support/welding-projects/Pages/mower-trailer-detail.aspx>

Chipping hammer and welding jig***

Coat rack

Electrode holder***

Pedestal (for grinder)***

Welding table with positioner***

If you are itching to make a project that is not included in the list above, talk it over with your leader. It may be something that would make an excellent individual project.

WELDING TERMS

AC welder – A machine that produces an alternating current for striking the arc and running a weld bead.

alloy – A metal manufactured by combining a base metal with other metals or chemical elements in order to alter or improve its properties.

alternating current (AC) – An electrical current that reverses its direction at regular intervals. In one complete cycle the current spends 50 percent of the time flowing one way and the other 50 percent flowing the other way. The rate of change in direction is called frequency and is indicated by cycles per second such as 60 cycles per second or 60 hertz.

amperage – The measurement of the amount of electricity flowing past a given point in a conductor per second. Current is another name for amperage. Often referred to as “amps.”

arc – The physical gap between the end of the electrode and the base metal. The physical gap causes heat due to resistance of current flow and arc rays.

arc blow - The deflection of an electric arc from its normal path because of magnetic forces.

arc length – The distance from the tip of the electrode to the adjacent surface of the weld pool.

arc flash – See welder’s flash.

arc radiation – The electromagnetic energy given off by the arc that can injure eyes and burn skin. An operator can see the visible light radiation given off but cannot see the ultraviolet or infrared radiation. Radiation is often silent and undetected, yet injury occurs if operator does not wear protective gear and clothing.

arc welding – See SMAW.

auto-darkening helmets – These are welding helmets whose filter lens automatically darkens to the chosen filter shade within 4/10 of a second of the arc being struck. This is fast enough to protect eye from any damage.

AWS number - This is a 4-5 digit number that is written on every electrode. The American Welding Society (AWS) numbering system can tell a welder quite a bit about a specific stick electrode including what application it works best in and how it should be used to maximize performance.

backhand welding – A welding technique in which the electrode is pointed back towards the weld puddle as it is moved forward along the weld seam.

back-stepping – This is a welding technique where the general progression of welding may be left to right, but the bead is deposited in segments from right to left. This technique is used to avoid distortion, especially while welding on thin sheets.

back-up bar – This is a material, usually a metal strip, that is placed against the back side of an open joint to support and retain the molten weld metal. The back-up bar can be left in place or cut off.

back-up strip – See back-up bar.

base metal – The metal or alloy that is to be welded. Often referred to as the workpiece.

bead – The deposited filler metal on and in the workpiece created when the wire core of electrode is melted and fused into the base metal. From the exterior it appears as a series of tight, overlapping ovals. A stringer bead is a narrow bead made with only a dragging motion or light oscillation, while a weave bead is wider and made with more oscillation.

bevel – These are angles cut or grinded into the edge of workpieces. The purpose of a bevel is to make the root opening larger, allowing for more penetration.

bevel angle – The angle formed between the prepared edge of one side of the base metal and a plane perpendicular to the surface of the other side of the base metal.

butt joint – A joint between two metal parts that lie in the same plane. Filling the weld groove formed between the two plates' edges creates a single piece. This is the most common type of joint.

carbon steel – A steel that contains a certain amount of carbon. Low-carbon steels are some of the most commonly welded metals.

concave – Curving inward like the inside of a bowl.

conductor – A substance or material that readily allows electrical current to pass continuously along it.

constant current machines – An arc welding machine (power source) where the voltage will change with different arc lengths while only slightly varying the amperage, those the name constant current.

convex – Curving outward like the exterior part of a circle.

corner joint – A type of joint created between the edges of two metal parts and are situated at right angles to one another forming an L shape.

crater – A depression at the end of an arc weld bead caused by the force of the arc as it is withdrawn.

current – The movement or flow of an electrical charge through a conductor. In welding, it is the current that flows through the welding circuit during the making of a weld. It is measured in amperes.

DCEN: Direct Current Electrode Negative – See straight polarity.

DCEP: Direct Current Electrode Positive – See reverse polarity.

DC welder – A machine that produces a direct current for striking an arc and running a weld bead.

defect – A flaw in the weld metal or in the base metal that can cause a weld to fail.

There is a large variety of different weld defects such as a crack, slag inclusion, undercut, etc.

direct current (DC) – An electrical current that flows in one direction only.

distortion – The permanent shape change of the weldment due to the non-uniform expansion and contraction of the weld metal and adjacent base metal during the heating and cooling cycle of the welding process.

double fillet – Is when fillet weld is placed on both sides of a joint.

duty cycle – The number of minutes out of a 10-minute time period an arc welding machine can be operated at maximum rated output before it needs to cool down. An example would be 60% duty cycle at 300 amps. This would mean that at 300 amps the welding machine can be used for 6 minutes and then must be allowed to cool with the fan motor running for 4 minutes.

edge joint – A joint along the edges of two or more parallel plates whose faces touch.

electric arc welding – See SMAW.

electrically hot - Is a part of an electrical circuit that is electrically charged.

electrical circuit – The path taken by an electrical current flowing through a conductor from one terminal of the source to be load and returning to the other terminal of the source.

electrode – The conductive element creating the electric arc between itself and the base metal. In arc welding, the electrode melts and becomes a part of the weld. Also referred to as stick or rod.

electrode cable – The electrical conductor/cable between the source of the arc current (the welding machine) and the electrode holder. To prevent injury the cable must be in good condition and correctly installed.

electrode holder – An insulated hand clamp used for holding and conduction current into an electrode during welding.

electrode lead – See electrode cable.

electrode size – The size of the electrode is determined by the diameter of its metal core, not by the diameter including the flux coating. The diameter is often given in imperial measurements such as 1/8" or 5/32".

fast-freeze electrode – A SMAW electrode that solidifies quickly. Fast-freeze electrodes are ideal for overhead welding.

fill passes – A progression of weld passes with the purpose of filling the joint with metal.

filler electrode – A SMAW electrode that fills up a joint quickly. Fast-fill electrodes are ideal for large workpieces.

filler material – Metal deposited into the weld that often adds strength and mass to the welded joint. In SMAW, the metal from

the electrode's wire core acts as the filler metal.

fillet weld – A type of weld that is triangular in shape and joins two surfaces at right angles to each other in a lap joint, T-joint, or corner joint. Fillet welds are the most common types of welds.

filter shade – The shaded protective lens inside the welder's helmet that filters out harmful rays and intense bright light. The amount of shading required depends on the welding process, electrode size, and amount of current used.

fixed-shade helmets – A welding helmet where the user must manually change the filter shade.

flange welds – The welds used to fuse edge joints.

flat-position welding – The welding position used to weld from the upper side of the joint. The face of the weld is horizontal.

flux – A nonmetallic material coating the wire core of an electrode. Flux is used to protect the weld puddle and solid metal from atmospheric contamination and creates slag on top of the weld bead.

forehand welding – A welding technique in which the electrode is pointed in the direction of welding, with the tip pointed away from the bead it is forming.

forge – A furnace or hearth where metals are heated and then hammered into shape. Forge welding is a process by which a

blacksmith hammers near-molten metals together to create a weld.

freezing – Is a term used in SMAW to describe the electrode getting stuck to the base metal.

fume – Metallic vapor that is emitted during the weld process.

fume plume – A cloud-like area where welding fume collects. The fume plume contains solid particles from the consumables (electrodes), base metal, base metal coating and gases formed in the process, which include oxides of nitrogen and ozone.

fusion – The melting together of filler metal and base metal, or of base metal only, to produce a weld.

gauntlet gloves – Leather gloves used in welding whose long cuffs cover most of the forearm.

groove angle – The angle of the groove between the two workpieces that are welded together.

groove face – The exposed surface of the groove weld in between workpieces.

groove weld - A type of weld made in the groove between workpieces.

ground cable – The electrical conductor/cable between the arc welding power source (the welding machine) and the ground clamp. Also called ground lead or workpiece lead. To prevent injury, the

cable must be in good condition and correctly installed.

ground clamp – Part of the welding circuit that is an adjustable clamp used to fasten the ground cable (work lead/cable) to the workpiece. Also referred to as workpiece connection.

ground lead – See ground cable.

grounded – Grounding refers to a return path for electric current to the service panel or a direct physical connection to the Earth. Having an electrical circuit grounded gives the electricity a route to go that is away from the operator, which will help to prevent electrical shocks.

heat-affected zone (HAZ) – The portion of the base metal that has not been melted, but whose mechanical properties have been altered by the heat of welding.

helmet – See welding helmet.

horizontal –position welding – A common welding position used for fillet and groove welds. For fillet welds, welding is performed on the upper side of a horizontal surface and against a vertical surface. For groove welds, the weld axis lies in a horizontal plane, and the weld face lies in a vertical plane.

insulation – Material that does not allow for the easy flow of electricity.

intermittent welds –A weld in which the continuity is broken by recurring unwelded spaces.

jig – An apparatus used by welders to align and hold parts in a fixed position while the weld is being made.

joint – The junction or edges of material that are to be joined or have been joined. There are five basic types of joints: butt, corner, edge, lap and T.

lap joint – A type of joint between two overlapping metal parts in parallel planes.

leg of a fillet weld – The distance from the root to the toe of the fillet weld (from the intersection of the joint to the end of the weld). There will be a leg for each plate. The size of the fillet weld is determined by the length of its legs.

live circuits – An electrical circuit which is electrically charged.

low-hydrogen electrode – A covered arc-welding electrode that provides an atmosphere around the arc and molten weld metal which is low in hydrogen. Such electrodes minimize the possibility of hydrogen related cracking.

manual dexterity – Skill or agility in using the hands or body.

mill scale – A black scale of magnetic oxide of iron formed on iron and steel when heated for rolling, forging, or other processing.

multiple pass weld - Successive beads laid down upon each other until a joint is filled. Multiple passes are required when welding thick metal plates or repairing large cracks.

natural material – Materials derived from plants or animals such as leather, cotton and wool. For welding, leather covering provides the welder with the most protection.

oscillation – A back and forth movement.

out-of-position – Any welding operation in which the parts are not laid out flat in front of the operator, such as vertical or overhead welding.

over-head position – The welding position in which welding is performed from the underside of the joint. Overhead-position welding is the most difficult welding position.

parent metal – Also called “base metal”, this is the metal or steel that you are actually welding on.

peen – To strike with the rounded end of a hammer in order to bend or shape a sheet of metal.

penetration – Describes how deeply the weld metal extends into the joint. The deeper the penetration, the stronger the joint.

polarity – The direction of the flow of electrical current in circuit.

porosity – Tiny holes or bubbles in the weld bead formed by gas entrapment during solidification of the weld metal. Porosity can weaken the weld and lead to cracking and often cannot be seen from the face of the weld.

power disconnect switch – A switch used to make sure that an electrical circuit can be completely de-energized from service or maintenance.

primary voltage – The voltage of the power line or generator from which the welding source of power is operated. Primary voltage is the input voltage.

primary voltage shock – An electrical shock from 120-180 volts that occurs in arc welding from touching a lead inside a switched-on welder and then touch the welder case or other grounded metal at the same time. Primary voltage shock is strong enough to be fatal.

profile – a shape cut out of a blank sheet.

puddle – See weld pool.

quench – To cool suddenly by plunging into a liquid.

reverse polarity – The direction of current flow through a welding circuit when the electrode lead/cable is connected to the positive terminal and the ground lead/cable is connect to the negative terminal of a DC welding machine. Also called DCEP.

rod – See electrode.

root edge – A root face of zero width.

root face – The surface of the joint that will be included in the weld that has not been prepared with a bevel.

root opening – The gap between base metal plates at the root of the joint.

root pass – The first weld bead deposited at the root of a joint in a multiple pass weld.

secondary voltage shock – An electrical shock from 60-100 volts that occurs in arc welding from touching the electrode while another part of the body touches the workpiece.

sheet metal – Thin metals, general between 12 and 24 gauge, used in auto bodies, household appliances and HVAC applications.

shielded metal arc welding – See SMAW.

shielding gas – Inert, non-flammable, non-reactive gas released, from an electrode's flux, around the weld zone protecting the arc area and weld puddle from reacting negatively with the atmosphere.

single fillet – A fillet weld made only on one side of the joint.

skull caps – The beanie worn by welders to protect their scalp from burns.

slag – A non-metallic waste product formed from the non-metallic impurities during the SMAW process. Molten slag floats to the top of the weld pool and then forms a hardened protective coating over the weld bead. This solidified slag also insulates the weld and slows the cooling rate. Weld beads must have slag chipped off with a hammer and brushed clean before additional weld beads are applied.

slag inclusion – Non-metallic solid material entrapped in weld metal or between weld metal and base metal.

SMAW – Stand for shielded metal arc welding. Is an electric welding process by which metal workpieces are melted together with a consumable electrode creating an arc between itself and the workpieces. The coating on the electrode provides shielding during the process and deposits slag over the weld.

soapstone – A soft rock consisting largely of talc. Used in welding to draw on base metal and highlight joints.

spatter – Metal droplets blown by welding arc that become scattered around the weld zone. Spatter does not form part of the completed weld.

square-groove weld – A type of groove weld with a slight separation at the edges of the base metal parts. Edges of metal parts are not prepared with a bevel or profile. This is the most economical groove weld to prepare.

stick – See electrode.

stick welding – See SMAW.

stinger – See electrode holder.

straight polarity – The direction of current flow through a welding circuit when the electrode lead/cable is connected to the negative terminal and the ground lead/cable is connected to the positive terminal of a DC welding machine. Also called DCEN.

stringer bead – A type of weld bead formed by moving the electrode straight across the joint without using a weaving motion.

synthetic materials – Man-made materials, such as polyester and rayon, that are created through chemical processes from raw materials that are often petroleum based. These materials are not suitable to wear while welding.

tack welds – Small weld used to hold the parts of what you're welding in place. Final welds are made right over the tack welds.

T-joint – A type of joint between two metal plates located at right angles to one another to form a T.

travel angle – The angle less than 90 degrees between the electrode and the weld.

travel speed – The speed with which the welder runs a bead during welding.

tensile strength – A measure of the ability of material to resist a force that tends to pull it apart. It is expressed as the minimum tensile stress (force per unit area) needed to split the material apart.

ultraviolet (UV) and infrared rays – Intense electromagnetic rays that in welding are given off by the arc. These rays can cause skin and eye burns and even permanent eye damage.

undercut – A groove melted into the base metal, by the heat and force of the arc, adjacent to the weld toe or weld root and left unfilled by weld material. This is a weld defect that produces a weak spot in the weld.

V-groove weld – A groove weld with an opening in the shape of the letter "V". V-groove welds require more joint preparation but less weld metal.

vertical-position welding – The welding position in which welding is done on a vertical surface where the axis of the weld is also vertical. Vertical-position welding is more difficult than flat- or horizontal-position welding.

voltage – The pressure or force that pushes the electrons through a conductor. Voltage does not flow, but causes amperage or current to flow. Voltage is sometimes termed electromotive force (EMF) or difference in potential.

weave bead – A type of weld bead made with transverse oscillation. This type of bead deposits more weld material than a stringer bead.

weld – A mix of metals that joins at least two separate parts. Welds can be produced by applying heat or pressure, or both heat and pressure, and they may or may not use an additional filler metal.

weld bead - See bead.

weld metal – The electrode and base metal that was melted while welding was taking place. This forms the weld bead.

weld pass – A single progression of welding along a joint. The result of a pass is weld bead or layer.

weld pool – The dime-sized pool of molten metal that is created by the heat of the arc

as the weld is being made. It can consist of metal from the parent material alone, from the parent material combined with the filler material or mostly just the filler material. The weld pool is central to the success of the welding process.

weld puddle – See weld pool.

welder – One who performs manual or semiautomatic welding.

welder's eye – See welder's flash.

welder's flash – An extremely painful condition that results from even brief exposure to ultraviolet and infrared radiation, that is created during welding arc, without wearing proper eye protection. Welder's flash can feel like sunburn on the eye or having sand in the eyes and can take effect hours after exposure; it is usually a temporary condition. Also called arc flash or welder's eye.

weld face – The exposed surface of a weld on the side from which the welding was done.

weld root – This refers to the points where the bottom or back of the weld intersects with the base metal. In a fillet weld, the root is the point of deepest penetration. OR this can also refer to the portion of the joint to be welded where the members approach closest to each other. In cross section, the joint root may be a point, a line, or an area.

weld size – With a groove weld, the weld size indicated by joint penetration. With a fillet weld, the weld size is indicated by the leg length of the fillet.

weld toe – The point at which the weld face and the base metal meet.

welding – A joining process that uses heat, pressure, and/or chemicals to fuse two materials together permanently.

welding circuit – The electrical path in which the welding current flows. The circuit consists of the output circuit of the welding power sources (the welding machine), the electrode cable, the electrode, the arc, the base metal, the ground clamp and the ground cable.

welding helmet – A device, equipped with a cover plate and a filter plate, designed to be worn on the head to protect eyes, face, and neck from arc radiation, radiated heat, spatter or other harmful matter expelled during some welding and cutting processes.

welding position – The relationship between the weld pool, joint, joint members, and welding heat source during welding. The positions for plate welding are flat, horizontal, vertical and overhead.

welding rods – See electrode.

welding sequence – The order in which the component parts of a structure are welded. Planning welding sequence is important for the control of distortion and to achieve ultimate strength in weldments.

weldment – A welded joint.

WHMIS – Canada's national system for hazardous material communication, the WHMIS, or Workplace Hazardous Materials Information System, was implemented to

label containers of controlled products, create material safety data sheet and educate workers. The eight WHIMS symbols are circular icons with corresponding classes.

work angle – The angle less than 90 degrees between a line perpendicular to the workpiece and a plane determined by the electrode axis and the weld axis. The

work angle is used to center the weld bead on a given application.

work lead – See ground cable.

workpiece – See base metal.

workpiece connection – See ground clamp.

workpiece lead – See ground cable.

RESOURCES

There are many resources available if you want to supplement the material supplied in this manual or to continue honing your welding skills outside of the scope of 4-H. Below is a list of resources, which have been subdivided into categories to assist in your search.

Recommended Books Used in Production of This Manual

(These books are highly recommended. They were used as a basis for this manual, and contain additional information and exercises which could easily be adapted for a 4-H club.)

- New Lessons in ARC WELDING, The Lincoln Electric Company 1981
- Audel Welding Pocket Reference, James E. Brumbaugh and Rex Miller, Wiley Publishing Inc. 2007
- Welder's Handbook, Robert Finch, Penguin Group Inc. 2007

Other Printed Resources Used in Production of This Manual

- Arcs & Sparks: Shielded Metal Arc Welding, (Ohio 4-H Welding Project) The Ohio State University 2002
- Shielded Metal Arc Welding (S.M.A.W.), (Manitoba 4-H Welding Project) Manitoba 4-H Council 2005
- Welding, (Saskatchewan 4-H Welding Project) Saskatchewan 4-H Council 1985
- Arc Welding Projects: Volume V, James F. Lincoln Arc Welding Foundation 2009

Online Resources Used in Production of This Manual (Pictures) as of August 25, 2014.

- risun.en.supplierlist.com
- www.princessauto.com
- www.signtorch.com
- www.landmarkonline.co.za
- www.directindustry.com
- www.northernsafety.com
- www.tpub.com
- canstockphoto.com
- www.worksafefbc.com
- www.safetyoffice.uwaterloo.ca
- www.leanordsafety.com
- www.lisgar.net
- www.toolstation.com
- www.lincolnelectric.com
- www.weldguru.com
- nasdonline.org

- stevenling-ilpks.blogspot.com
- sarinamkjb.wikispaces.com
- www.waybuilder.net
- constructionmanuals.tpub.com
- shaiksameeruddin.wordpress.com
- www.countrysidemag.com
- origin.autospeed.com
- www.wballoys.co.uk
- cimc.alcaweb.org
- www.weldingengineer.com
- weldinganswers.com
- mitcalc.com
- www.spartanmechanics.net
- www.neow.net
- navyaviation.tpub.com
- www.meadinto.org
- www.metals4u.co.uk
- manikamsutera.blogspot.com
- www.weldingtipsandtricks.com
- www.sweethaven.com
- deltaschooloftrades.com
- www.thefabricator.com

Recommended Online pdf Files Used in Production of This Manual

- http://www.millerwelds.com/pdf/guidelines_smaw.pdf
- <http://deltaschooloftrades.com/DELTA%20BOOK%202009.pdf>
- <http://www.lincolnelectric.com/en-us/education-center/Documents/SMAWFacilitatorGuide.pdf>
- <http://www.globalsecurity.org/military/library/policy/navy/nrtc/14250.htm> (Chapter 3 and 7)
- <http://www.millerwelds.com/pdf/PrinciplesSMAW.pdf>

Other Resources

- **Books:** There are many books on welding available through the Saskatchewan Library System. (<http://www.sasklibraries.ca/>) or through book stores.
- **Canadian Welding Association** (<http://www.cwa-acs.org/>): This national association has offices in Saskatoon and Regina. They are valuable resource providing many services to those in the welding profession and those interested in welding. Hosting local events and providing access to training and education courses and materials are just a few of the many services they offer.
- **Lincoln Electric** (www.lincolnelectric.com/): This is a company that manufactures and sells welding equipment. Their website contains a great deal of valuable information, including project plans and educational material. In fact, the company has a strong

education mandate and if you contact them directly, they provide education kits for instructors that contain books, DVD and other teaching resources.

- **ESAB Welding and Cutting Canada** (<http://www.esab.ca/>): This is a company that manufactures welding equipment. Their website contains a lot of useful information for those interested in welding. The portion of their website dedicated to education is especially helpful. They even offer what they call “ESAB University” that offers several free online course handbooks. The handbook found at http://www.esabna.com/EUWeb/AWTCC/Lesson2_1.htm was used as a resource creating this manual.
- **Miller Electric** (www.millerwelds.com/): This is a company that manufactures and sells welding equipment. The resource section of their website contains a host of educational material, including project plans.
- **American Welding Society** (www.aws.org/): This welding society is a great resources providing a variety of different services for those in the welding profession. Beyond having a section of their website dedicated to education, they also offer online courses and workshops (that you must pay for) that cover many different topics for those wanting to learn more about welding. The AWS does have a Canadian branch (<http://www.aws.org/canada/>), but, at the time of publishing, the website lacks resources and information.
- **Local Welding Shops**: Many communities have local welding shops that do fabrication and/or repair. Contacting these local businesses may yield skilled people who can assist with the Project, provide other types of support, and perhaps allow the club to visit the shop.
- **Online Instructional Videos**: Websites like YouTube and eHow have a multitude of instructional videos that cover an endless number of welding topics and techniques.
- **Welding Supply Stores**: There are a number of stores throughout Saskatchewan dedicated to supplying welders with what they need. You may find the staff at these stores to be an invaluable source of information and resources.

Schools Offering Welding Programs in Saskatchewan

- Carlton Trail Regional College – <http://www.ctrk.sk.ca/programs>
- Great Plains College – <http://www.greatplainscollege.ca/>
- North West Regional College – <http://www.nwrc.sk.ca/>
- Northlands College – <http://www.trainnorth.ca/>
- Parkland College – <http://www.parklandcollege.sk.ca/>
- Saskatchewan Indian Institute of Technologies – <http://www.siiit.sk.ca/>
- Saskatchewan Institute of Applied Science and Technology – <http://gosiast.com>
- Southeast Regional College – <http://www.southeastcollege.org/>

ACKNOWLEDGMENTS

Appreciation is expressed to the following organizations who are among those that supplied technical information used in the development of this manual and granted permission for use of their illustrations to appear in this manual.

- Manitoba 4-H Council's "Welding" 4-H Project Manual and "Welding Leader Guide"
- Ohio State University "Arcs & Sparks" 4-H Project Activity Guide
- Golbalsecurity.org NAVEDTRA course "Steelworker Volume 01" chapters 3 and 7
- Miller Electric publications. Please note: The Miller Electric Mfg. Co. information included in this manual are reproduced with the permission of Miller Electric Mfg. Co., © Miller Electric Mfg. Co., All Rights Reserved.
- Lincoln Electric publications, including the book "New Lessons in ARC WELDING".



CANADA
4-H Saskatchewan

Saskatchewan 4-H Council
3830 Thatcher Avenue
Saskatoon SK S7K 2H6
PH: 306-933-7727
Fax: 306-933-7730
Website: www.4-h.sk.ca